

# Applications & Markets

5G Networks

Automotive

Consumer

Data Centers

e-Mobility

Energy Storage Systems

IoT

Industry 4.0

Lighting

Server & Storage

Test & Measurement

Artificial Intelligence & Machine Learning

**HEILIND**

[amphenol-cs.com](http://amphenol-cs.com)



# Solving Your Electronic Design Challenges

## Content

<b>Company Introduction</b>	4-5
<b>Applications &amp; Markets</b>	
5G Networks	6
Automotive	14
Consumer	28
Data Centers	34
e-Mobility	40
Energy Storage Systems	46
IoT	50
Industry 4.0	56
Lighting	62
Server & Storage	66
Test & Measurement	76
Artificial Intelligence & Machine Learning	82

# Amphenol Overview

**Amphenol Communications Solutions (ACS), a division of Amphenol Corporation, is a world leader in interconnect solutions for Communications, Mobile Consumer Products, RF, Optics, Broadband and Commercial electronics markets.**

Amphenol Corporation is one of the world's largest designers and manufacturers of electrical, electronic and fiber optic connectors and interconnect systems, antennas, sensors and sensor-based products and coaxial and high-speed specialty cable.

ACS has an expansive global presence in research and development, manufacturing, and sales. We design and manufacture a wide range of innovative connectors as well as cable assemblies for diverse applications including server, storage, data center, mobile, RF, networking, industrial, business equipment and automotive.

## Strong Global Presence

We place heavy emphasis on R&D for both new product and technology development, focusing on the advancement of the next generation of high-speed interconnects and power distribution solutions as well as innovative manufacturing solutions.

- Our R&D centers worldwide have registered thousands of patents and licensing agreements, developing some of the world's first innovations in connectors such as Shield-less High-Speed Connectors, Ball-Grid-Array Attachments, economical Stamped High-Power Contacts and cost effective yet reliable plating processes.
- We relentlessly seek improvements of our products, increasing our solutions' overall cost effectiveness, precision and reliability. This ensures that we meet or even surpass the ever changing needs and expectations of market trends.

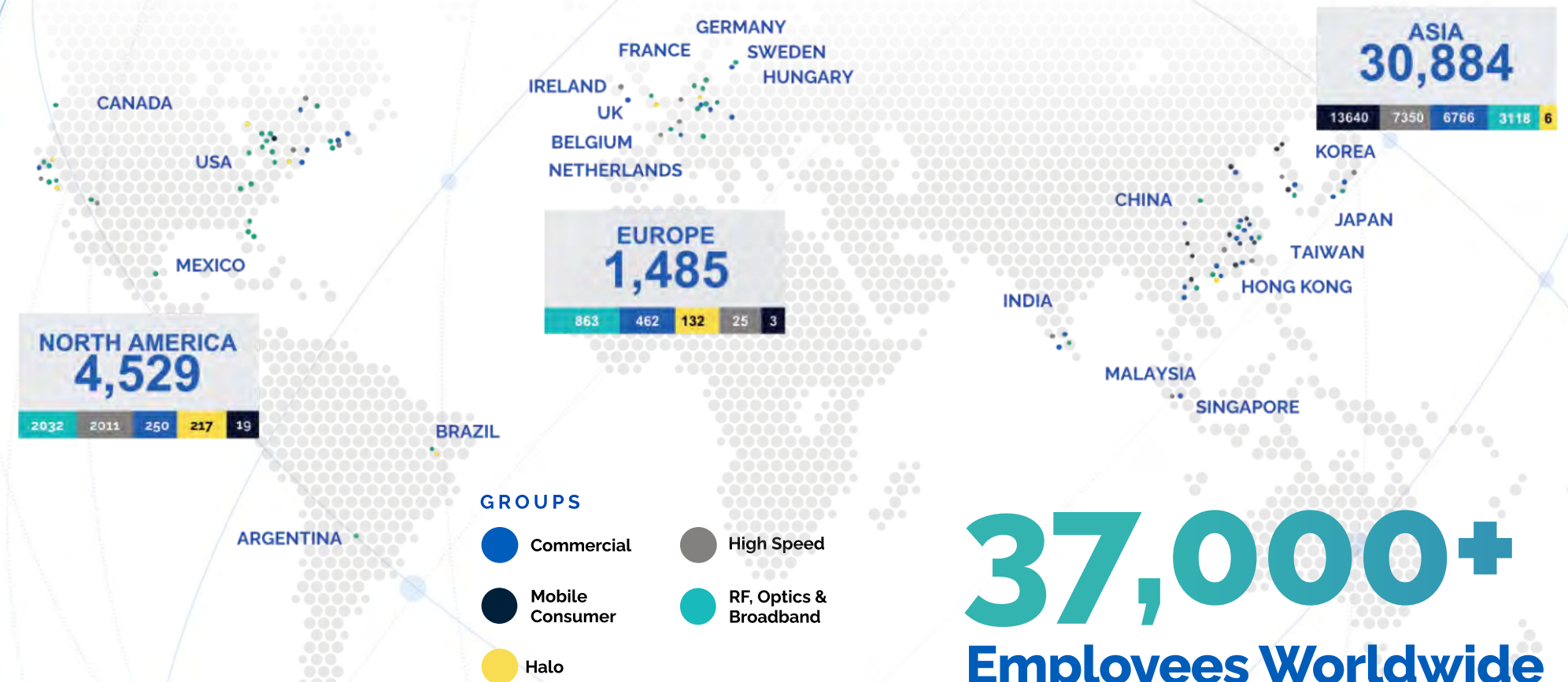

# 37,000+ Employees Worldwide

## APPLICATION SCOPE

# 5G Networks

The future of speed is at our fingertips with the advent of 5G — changing the way the world connects and communicates.



### Baseband Unit

Amphenol offers interconnect solutions ranging from high-speed I/O connectors and cable assemblies, harsh environment connectors to power connectors and more for designing efficient functioning baseband units.



### Remote Radio Units (RRU)/Antennas

From high speed rugged outdoor I/O connectors to Ethernet connectors and transceivers, Amphenol has the best solutions to offer for RRUs and Antennas.



### Edge Servers / Edge Data Center

Edge servers can be simply described as high-power computers or servers which are placed near or at the "edge" of the 5G network. Our connector portfolio can address every edge server application.



### Network Switch & Gateway

Network gateways, switches and servers are an integral part of the 5G network, especially inside the 5G core, where all the post processing of the signal is carried out before being sent to the data centers.

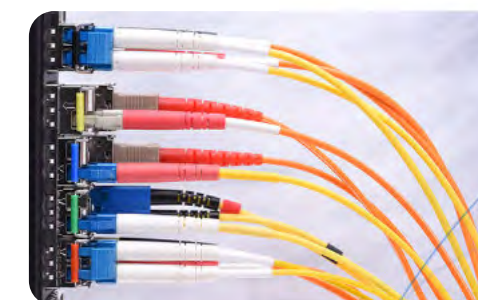

### Transport / Fronthaul / Backhaul / Transponder

Transponders are interconnected units associated with the RRU or the BBU and play a large part in the transport of the 5G signal. Amphenol provides connectors that go inside the transponders and routers that assure a smooth run of the 5G transport.

## 5G Networks



### Mini Cool Edge IO

- Up to 64Gb/s PAM4, PCIe® Gen 4, PCIe® Gen 5, PCIe® Gen 6, over 1.0 meter transmission distance
- 0,60mm pitch connectors support both cable and card edge connections
- Options for 92Ω, 85Ω and 95Ω impedance and various pin number options - meeting PCIe®/NVMe/SAS/SFP(+)/QSFP specifications



### Mini Cool Edge for GEN Z/EDSFF/OCP

- 0,60mm pitch connector, supports high speed up to 112G PAM4
- Designed to meet SFF TA1002, Gen Z, EDSFF, OCP NIC 3.0 specifications
- Vertical, right angle, straddle mount and orthogonal options are available



### PCIe® M.2 Gen 5 and Gen 4

- 67 contacts on 0,50mm pitch fully compliant with PCI-SIG PCIe® M.2 specification
- Dual Stacked, Shielded versions are available
- Right angle, vertical and various connector heights and keying options offered



### Multi-Trak™

- Combines original PCIe® and Mini Cool Edge IO in one connector to provide both power (21A) and high/low-speed signal
- Up to 56Gb/s PAM4, PCIe® Gen 5, and target PCIe® Gen 6
- Options for 85Ω impedance and various pin number options - meeting PCIe®/NVMe/SAS/OCP DC-MHS/ SFF-TA-1033 specifications



### Double Density Cool Edge for Ultra Compact Design

- 0,80mm pitch, power and signal hybrid connector
- Highly configurable wafer design for differential, single-ended and power options
- Supports high speed of up to 32GT/s(or 56GT/s PAM4) capability



### PCIe® Gen4 and Gen5

- X1, X4, X8, X16, X24, X32 standard links
- 1,00mm pitch, vertical and right angle with options for ridge, locked latch, side latch, blade hold down, open wall
- Extensive range include options for surface mount, through-hole solder, press-fit and straddle mount terminations and keying options offered



### ExtremePort™ Z-Link

- Compliant with Gen-Z and OCP NIC specifications, SFF-TA-1002/1020 solution
- High speed of up to 56Gb/s PAM4
- Supports both cable and card edge applications



### Standard Cool Edge 0.8mm for Automotive and 5G Antenna

- Robust design with EMI shielding for Automotive Ethernet and Power applications
- Hybrid option for small cell active antenna BTB application
- One-piece small form factor to save space



### DDR5 SO-DIMM Connectors

- 262 positions connector in high-density design of 0,50mm pitch
- 4,00mm, 8,00mm, 5,20mm and 9,20mm height
- Right angle and vertical orientation with SMT mechanical hold-downs



### DDR SMT Memory module Connectors

- Designed to meet JEDEC SO-016, SO-017, SO-019 and SO-023 specs
- U DIMM/R/LR Socket, Metal tab, Standard/Narrow/ latch available



### BergStak® Secure 1.00mm

- High security, high density
- EMI Shielding
- Speed up to 32Gb/s.

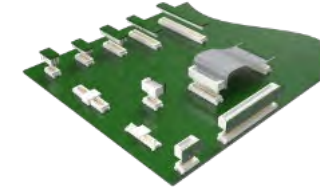

### Conan® 1.00mm

- Secure, reliable connector
- Audible "click" to ensure perfect mating
- Speed up to 8 Gb/s.



### PSAS, SAS and SATA Connectors

- SAS connectors (29-pins) support hot plugging and blind mating of HDDs/SSDs, 2 signal lanes support up to 24Gb data rate (SAS 4.0).
- PSAS connectors (68pins) support SAS HDD and NVME SSDs with 2 SAS lanes supporting up to 24G data rate and 4 PCIe lanes supporting up to 32G (PSAS 5.0) data rates.

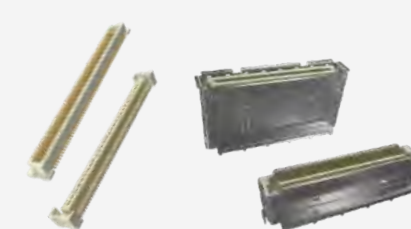

### BergStak® 0.80mm

- Ideal for use in high density applications
- Wide range of positions and stack heights
- Speed up to 16 Gb/s.

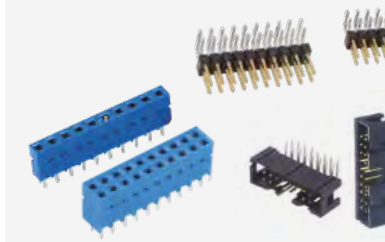

### Modular Systems 2.54mm/2.00mm

- Dubox®, Quickie®, BergStik®, PV® 2,54mm, Minitek® 2,00mm
- Industry proven connector system
- Board to Board, Wire/Cable to Board



### Compression, Board to Board Connectors and Interposer

- Provides a connection between either two PCB modules or one PCB and an electrical module
- Single-piece compression-type or two-piece board-to-board surface mount connectors



### ComboStak® 0.80mm / 2.00mm

- Hybrid and medium power solution
- 0,8A signal, 20A power
- Signal speed up to 12Gb/s.



### Power Connectors

- Wire to Board connectors in 3,0 mm and 4,2mm pitch with current ratings from 6,5A to 20A per pin
- Designed for IT and Datacom applications

## 5G Networks



### PwrBlade® MiniMezz

- Up to 50A per contact (high power) and 25A per contact (low power)
- Available stack heights range from 8mm to 20mm (tooled in 1mm increments)
- +/- 0.80mm gatherability for blind mate applications



### PwrMAX® I/O Cable Connector System

- Rated up to 50A/Contact (100A/column) without exceeding 30°C temperature rise in still air
- Latching options available
- Patented GCS® and GXT® plating



### SheerPwr®

- Available in 3.6mm, 6.0mm, and 8.0mm pin diameter options
- Large beam deflection range handles up to ±0.40mm of permanent misalignment
- Low 6.80mm connector height



### PwrBlade® Mini Cable-to-Board Connector

- Rated up to 25A per power contact (50A/column) without exceeding 30°C temperature rise in still air
- Modular tooling design
- 12AWG for power contacts and 26AWG-22AWG available for signal contacts



### PwrBlade® ULTRA HD

- Up to 85A per contact
- 2.0mm high density signal pitch
- Ultra-low profile height of 9.6mm above board for optimized airflow



### CoolPower® SDM

- Up to 35A per pin, high current Coolband contact technology
- Backplane, coplanar, and orthogonal configurations available
- 2 position or 4 position available



### PwrBlade® Mini Board-to-Board Connector

- Rated up to 45A per high power contact (4 adjacent contacts)
- Low profile 8.10mm height above board
- Modular tooling designs



### PwrBlade® IO

- Up to 60A per contact (high power) & 25A per contact (low power)
- Power & signal contacts are highly configurable
- Wide range of wire sizes available



### EnergyEdge™ X-treme

- 3000W at 12V
- Available in straddle mount, right angle, right angle coplanar, and vertical configurations
- 25% increase in current linear density



### PwrMAX® G2

- Highest density blind-mate Power and Signal connector series
- Up to 130A per contact and 18% size reduction
- Orthogonal, mezzanine, coplanar and right-angle configurations available for both PCB and busbar applications



### Ruggedized

- Ruggedized, IP67 sealed
- Connectors & cables
- RJ, USB, USB-C, D-Sub, HDMI
- MRD Circular latching
- FLH rectangular latching
- Industrial, commercial, lighting



### SD/Micro SD Express Series Connectors

- PCIe Gen3\*1/ Gen4\*1 lane
- Backward compatible to UHS-I/UHS-II in one socket (3-in-1 solution)
- Push push/push pull structure



### High Temperature Backplane Connectors

- Feature-packed connectors designed for use in higher operating temperature applications. Compliant to EN45545



### Single Pair Ethernet

- Next gen ruggedized interface
- IEC 63171-6, PoDL
- IP20 & IP67 connectors & cables
- Industrial Ethernet to the sensor and actuator level

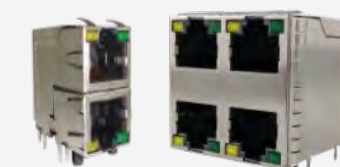

### RJ / Modular Jacks

- Cat5, Cat5e, Cat6, Cat6A
- Single port, ganged, stacked multi-port, LEDs, shielded
- Vertical, right angle
- PoE++ capability
- Industrial, commercial, medical, consumer, military applications



### Millipacs® Plus

- Configurable meeting designers' choice of signal data rates from 3Gbps to 25Gbps and power up to 40A and with multiple guiding options
- Compliant to Hardmetric equipment practice and complementary to 2mm Millipacs standard
- Options for Hotswapping, EMI shielding and high temperature



### ix Industrial Ethernet

- Next gen ruggedized interface
- IEC 61076-3-124, Cat6A, PoE++
- IP20 & IP67 connectors & cables
- ix-Mag with integrated magnetics
- Factories, Robotics applications



### RJMG

- 10/100T, 1GBT (10/100/1000-BT), 2.5G, 5G, 10G, Power Over Ethernet (PoE, 15W-150W), integrated with surge protection.
- Commercial 0-70°C and industrial -40-85°C & -40-105°C.
- Meets IEEE802.3ab and supports various Ethernet PHY

# 5G Networks High Speed



## XCede® HD

SUPPORTS DESIGNS FROM 8G - 56G PAM4  
The de-facto standard for high performance backplane designs with industry leading density. Supports Embedded Capacitors.

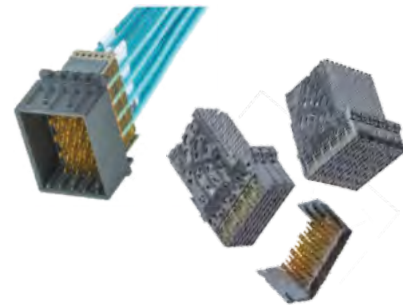

## XCede®

SUPPORTS DESIGNS FROM 8G to 56G PAM4  
Scalable and flexible design supports all your system requirements. Supports Embedded Capacitors; mechanically robust.



## Lynx™ & Lynx™ QD

HIGH SPEED AND DOUBLE DENSITY LOW-PROFILE BOARD-TO-BOARD CONNECTOR  
Low-profile flexible open pin field design available in 4-15mm heights at .6mm contact pitch, designed in multiple form factors. Optimized for density and cost. Supports data rates up to 28 Gb/s with PCIe Gen5 and 56G performance.



## ExaMAX®

COST OPTIMIZED WITH SCALABLE PERFORMANCE TO 112G PAM4  
Innovative design supports low insertion/extraction forces with reduced crosstalk and low insertion loss. Flexible architecture supports direct orthogonal, traditional backplane, coplanar and cable requirements.



## Paladin®

SUPPORTS DATA RATES BEYOND 112G PAM4; INDUSTRY-LEADING SIGNAL TO NOISE PERFORMANCE  
Consistent signal integrity performance over the entire mating range. Flexible architecture supports direct orthogonal, traditional backplane, mezzanine, coplanar and cable requirements up to 8P.

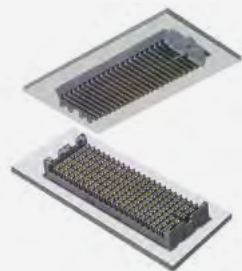

## Chameleon®

ADAPT AND ADVANCE TO THE NEXT GENERATION  
With performance speeds up to 25 Gbps+, Chameleon meets the demand for faster, smaller and more compact connector solutions. Chameleon delivers a new level of performance unlike any other platform connector on the market today.



## ExaMEZZ®

COST OPTIMIZED WITH SCALABLE PERFORMANCE UP TO 112G PAM4  
Innovative design supports low insertion/extraction forces along with reduced crosstalk and low insertion loss. Stacked height range from 14.5 to 67mm in 2- and 4- and 8-Pair configurations.



## Paladin HD®

DENSITY OPTIMIZED PERFORMANCE BEYOND 112G PAM4; ROADMAP TO 224G  
Achieves 144 diff pairs within 1U Orthogonal slot. Consistent signal integrity performance over the entire mating range. Flexible architecture supports right angle female, direct orthogonal, and cables up to 12P.



## cStack™

CUSTOMIZABLE SOLDERLESS INTERPOSER-BASED ONE-PIECE STACKER  
The Amphenol cStack™ high speed solderless interconnect solution provides limitless flexibility for board-to-board mezzanine applications and board-to-board stackable and coplanar applications when terminated to a flex circuit.



## M-Series 56 Mezzanine Connectors

56GB/S HIGH SPEED MEZZANINE BGA CONNECTOR SYSTEM  
Leveraging proven technologies, including an industry leading BGA design, offering superior self-aligning and self-leveling. With a next generation differential pair contact design for up to 56Gb/s NRZ and 112Gb/s PAM4 performance.



## 50G SFP56 LR Transceivers

SUPPORTS 53.12GB/S DATA RATE & LOW POWER.  
The module is compliant with IEEE 802.3 cd, SFF-8472 Rev 12.4, and compatible with SFF-8432 and applicable portions of SFF-8431 Rev. 4.1.

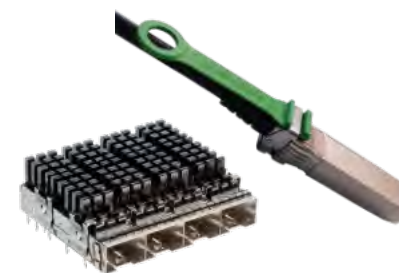

## ExtremePort™ SFP112G Connectors & Cable Assemblies

SUPPORTS DESIGNS FROM 28G, 56G, PAM4 And 112G PAM4. Passive & active cables; 26AWG to 32AWG cable. Stacked, ganged and belly-to-belly board connector and cage configurations with heat sinks and light pipes. Available in all 4x form factors.

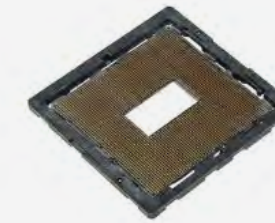

## cLGA® Land Grid Array Socket System

HIGH PERFORMANCE, LOW COST CHIP-TO-BOARD APPLICATION  
Designed to bring conventional connector material construction to high performance, low cost chip-to-board applications. Used in applications ranging from handheld computer products to supercomputer systems.



## ExtremePort™ QSFP DD 112G Connectors & Cable Assemblies

SUPPORTS PER PORT 200G, 400G AND 800G PAM4  
8 lanes per cable – 28G, 56G & 112G per lane capability. Double the bandwidth per port vs. QSFP. Backwards plug compatibility with QSFP. Available in all 4x form factors.



## DensiLink® OverPass™ Assemblies

112G DOUBLE ENDED HIGH PERFORMANCE CABLING INTERCONNECT  
DensiLink® OverPass™ products remove high speed signaling from the PCB and create a double ended, high performance cabling interconnect. These cables support 56G and 112G signaling in hardware system designs.



## AirMax®

COST OPTIMIZED WITH SCALABLE PERFORMANCE UP TO 56G PAM4  
Traditional backplane offering including standard and inverse gender. Standard is 3-, 4- and 5-Pair.



## QSFP28/56/112G Connectors & Cable Assemblies

SUPPORTS PER PORT DESIGNS FROM 100G, 200G AND 400G PAM4  
4 lanes per cable – 28G, 56G and 112G per lane capability. Passive & active cables; 26AWG to 32AWG cable. Stacked, ganged and belly-to-belly connector and cage configurations. Available in all 4x form factors.



## TR Multicoax Connector

HIGHEST DENSITY HIGH SPEED COAX CONNECTOR  
TR Multicoax delivers superior signal integrity from multiple high speed analog or digital channels. With a choice of 20GHz, 40GHz, or 70GHz configurations, users can upgrade their connectors according to bandwidth requirements on their application.

# APPLICATION SCOPE Automotive

Amphenol has a successful history providing interconnect solutions that adhere to industry standards like USCAR and meeting LV214 severity levels.



## EV Charging

With a wide portfolio of power products supporting 15A-1000A ratings, low contact resistance, high thermal support and component modularity, Amphenol offers the most efficient solutions for the modern EV charging station.



## Automotive Lighting

Modern automobiles are rich with ADAS features like smart LED lighting for adaptive headlights, and superior interior lighting. Amphenol provides a range of advanced USCAR2 compliant connectors like Minitek Microspace™, which are compact and meet LV214 standards.



## Advanced Electronics Systems

Amphenol brings a broad array of innovative technology and solutions to support the growth in the automotive industry, particularly in plating, signal integrity performance, and power management.

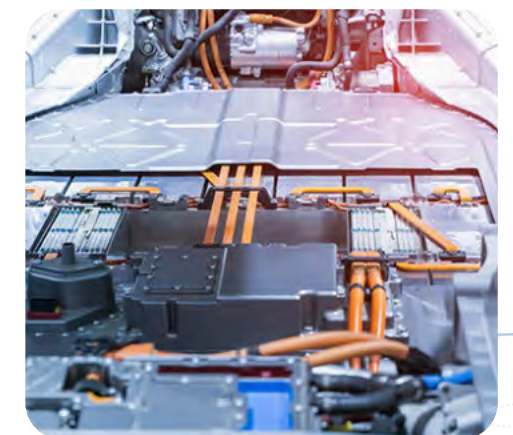

## Battery Management Systems

The battery is considered as the strategic component of any electric vehicle. Amphenol offers a range of compact, flexible high performing automotive grade connectors for these power circuit designs.





**NETBridge+™ Automotive Ethernet Connector System**

USCAR-2 COMPLIANT AUTOMOTIVE ETHERNET CONNECTORS. NETBridge+™ Automotive Ethernet Connector System is designed for automotive applications and can transmit up to 100Mb/s and 1Gb/s according to IEEE 100BASE-T1 and 1000BASE-T1 and will be upgraded to 10Gb/s.



**HSC Connector System**

USCAR-2 COMPLIANT COMPACT HIGH SPEED INTERCONNECT SYSTEM. HSC connector system is a fully shielded interconnect system that supports data rates up to 1Gb/s and more. With 0.50mm square terminals, it allows a lighter and smaller connector design.



**FloatCombo™ 0.50mm Floating Board-to-Board Connectors with Power Pin**

HIGH SPEED HIGH CURRENT POWER PIN BOARD-TO-BOARD CONNECTORS 0.50mm pitch floating board-to-board connector system with power pin is designed for applications that need large current and space saving.



**Ve-NET™ Multigigabit Differential Connector System**

Automotive-grade Ethernet solution developed according to USCAR-2 & LV214, along with miniaturized and various sealed/non-sealed configurations; Featured high data rates up to 50Gbps per port and highly compact and robust to fulfill automotive applications such as camera systems, ADAS, and Autonomous Driving. Supports Automotive Ethernet, LVDS, APIX 3 PCIe and FPD4.



**HSD (High Speed Data) Connector System**

COMPLIANT WITH USCAR-2 SPECS HSD connector system is a fully shielded interconnect system that can be used with shielded twisted quad cables. It has a high performance digital system for low-voltage differential signals which prevents interference from crosstalk and external sources.



**2.00mm FFC/FPC connectors with Autolock Mechanism**

NON-ZIF FLEX CONNECTOR WITH AUTOLOCK. LV214 S1 qualified non-ZIF flex connector with an autolock mechanism and surface mount termination.



**HSBridge+ Connector System**

USCAR-2 COMPLIANT AUTOMOTIVE GRADE USB TYPE C CONNECTOR. HSBridge+ connectors come with automotive grade USB Type C interface. These connectors have headers compliant to USCAR-30 USB and are performance tested according to USCAR-2.



**0.80mm Floating Board-to-Board Connectors - B406/B407/B410 Series**

HIGH SPEED BOARD-TO-BOARD WITH FLOATING MECHANISM. Amphenol's B406/B407/B410 series are 0.80mm pitch floating board-to-board connectors which support stack heights up to 23mm and positions from 30 to 120.



**0.50mm FFC/FPC Connectors with Autolock Mechanism - F308/F332 Series**

RIGHT ANGLE NON-ZIF FLEX AUTOLOCK CONNECTORS. USCAR-2 T3V2 qualified 0.50mm pitch right angle non-ZIF flex connector with an auto lock mechanism and surface mount termination.



**Automotive Grade PCI Express® Gen 5 Card Edge Connectors**

EXTEND DIFFERENTIAL SIGNALING TO 32GT/S FOR NEXT-GENERATION SYSTEMS. Amphenol's PCIe® Gen 5 straddle mount connectors outperform the industry standards with higher speed and are USCAR compliant.



**Automotive Grade PCIe® M.2 Gen 4 Card Edge Connectors**

HIGH DENSITY HIGH PERFORMANCE CONNECTOR. Amphenol's PCIe® M.2 Gen 4 USCAR compliant connectors provide 67 contacts on 0.50mm pitch and signal transmission speed of 16Gb/s.



**FlexFast™ Flex to Board Connector Solution**

Small size and low height flex to board connection solution. Compliant to USCAR2 and LV214 and designed for BMS, battery pack, Inverter+DCDC applications.



**FlexLock™ FPC-to-Board Connectors**

MORE FLEXIBLE SOLDERING AUTOMOTIVE GRADE CONNECTOR SYSTEM. FlexLock™ FPC-to-Board connector's compact design address the growing demand for automotive application market. The connector design is compliant to



**WireLock®**

RELIABILITY LOW MATING FORCE AUTOMOTIVE GRADE CONNECTOR SYSTEM. WireLock® is a 1.80mm pitch wire-to-board and flex-to-wire connector system. It's compact design addresses the growing need for space saving automotive-grade connectors. WireLock® is a double row connector system offering four coding types.



**Minitek MicroSpace™ High Voltage selective loaded Crimp-to-Wire Connector Platform**

COMPACT, ROBUST AND VERSATILE CONNECTOR SYSTEM. Minitek MicroSpace™ High Voltage selective loaded Crimp-to-Wire connector platform's unique design enables LV214 Severity-2 and performs at 3.81mm, 6.35mm, and 8.89mm pitch with 400V, 800V and 1200V.

**Minitek MicroSpaceXS™ 1.27mm Crimp-to-Wire Connector Platform**

COMPACT, ROBUST AND VERSATILE CONNECTOR SYSTEM. Minitek MicroSpaceXS™ Crimp-to-Wire connector platform's unique design meets LV214 Severity-3 and USCAR-T2V2 specifications.

**Minitek MicroSpaceXS™ Waterproof 1.27mm Crimp-to-Wire Connector Platform**

COMPACT, ROBUST AND VERSATILE CONNECTOR SYSTEM. Minitek MicroSpaceXS™ Waterproof Crimp-to-Wire connector platform's unique design is compatible to LV214 Severity-3 and USCAR-T2V2 specifications.

**DuraEV™**

PORTABLE AND FIXED BATTERY CHARGING AND DISCHARGING CONNECTORS. DuraEV™ is a standard connector solution offered with 2 power and 4/6 signal pins which employs a patented contact system that is capable of carrying a continuous current from 15A up to 70A with 10,000 mating cycles.

## Automotive



### BarKlip® XP Connectors for EV Charging

HIGH POWER AND LOW RESISTANCE BUSBAR CONNECTOR FOR EV CHARGING STATIONS. Amphenol's BarKlip® XP connectors feature independent points of contacts that provide overall lower resistance and greater overall efficiency.



### BarKlip® BK200 I/O for EV Charging

DIRECT PLUGGABLE CLIP THAT CONNECTS TO BUSBARS IN EV CHARGING STATIONS. Amphenol's BarKlip® BK200 I/O provides a convenient method of distributing up to 200A between busbars, cables and circuit boards. It features 14 fully independent cantilevered beams, providing a true compliant spring to adjust for variations in busbar alignment and surface finish.



### CoolPower® SDM Connectors for EV Charging

HIGH CURRENT COOLBAND POWER CONTACTS FOR MAXIMUM PERFORMANCE IN EV CHARGING STATIONS. CoolPower® Slim Drawer Mini (SDM) Connectors offer a high level of mating configuration flexibility, current density, and a thin profile making it ideal for compact board-to-board power interconnects.



### PwrBlade® Connector

The PwrBlade® power distribution connector system from Amphenol includes power and signal contacts to provide power distribution and power control in a single connector.



### PwrBlade® Cable Assembly

The PwrBlade® cable connectors are designed to mate to PwrBlade® right-angle or vertical board-mounted headers. By expanding beyond board-to-board applications, designers can now connect power supplies and power distribution subassemblies in a wider range of applications.

### PwrBlade+® Cable Connectors for EV Charging

PwrBlade+® cable connectors offer flexibility to meet a wide variety of customer needs. The connectors come in both Cable-To-Cable and Cable-To-Board solutions.

### PwrBlade+® Connector for EV Charging

The PwrBlade+® connector is a next generation AC/DC power distribution connector system for demanding applications requiring higher linear current density and low power loss.



## Automotive High Speed



### MEG-Array®

**INDUSTRY-PROVEN BGA ARRAY CONNECTOR** The MEG-Array® Mezzanine Connector system provides the high density and high-speed benefits of a large array supported by the reliability and low costs of standard surface mount PCB assembly.

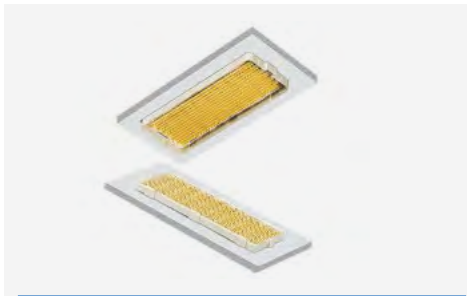

### MEG-Array® R+

**56GB/S HIGH SPEED MEZZANINE BGA CONNECTOR SYSTEM** Leveraging proven technologies, including an industry leading BGA design, offering superior self-aligning and self-leveling.



### Lynx™

**HIGH SPEED AND DOUBLE DENSITY LOW-PROFILE BOARD-TO-BOARD CONNECTOR** Amphenol's Lynx™ is a 4-row product offering doubling the density in a 2-row footprint that is suitable for a wide variety of applications in datacom, enterprise server, telecommunication, industrial.



### Lynx™ QD

**THE QUAD DIFFERENTIAL SOLUTION** Optimized for differential pair signaling, Lynx™ QD sets a new standard for density and flexibility that offers an innovative, high performance interconnect with PCIe® Gen 5 support.

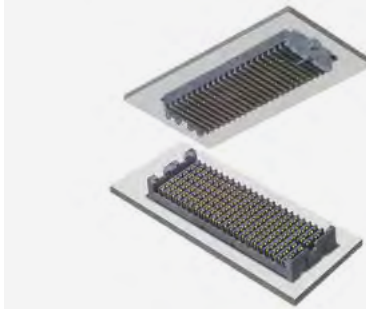

### Chameleon®

**ADAPT AND ADVANCE TO THE NEXT GENERATION** With performance speeds up to 25 Gbps+, Chameleon meets the demand for faster, smaller and more compact connector solutions. Chameleon delivers a new level of performance unlike any other platform connector on the market today.



### InfinX®

**OPTIMIZED FOR PERFORMANCE AND DIFFERENTIAL PAIR SIGNALING** The InfinX® high-speed mezzanine connector solution is designed to meet the needs of 25+Gb/s applications. Available in 4- and 6-Pair configurations, InfinX is your best choice for high speed board-to-board applications.

## Automotive RF



### AUTOMATE® Mini-FAKRA Connectors

The AUTOMATE® Mini-FAKRA connector series is a space-conscious, high-performance interface capable of supporting data transfer rates up to 20 Gbps. Ideal for compute modules, wire harnesses and camera applications. Custom sealed solutions available.



### AUTOMATE® Mini-FAKRA Cable Assemblies

AUTOMATE® Mini-FAKRA cables assemblies are designed with a compact, modular housing and available in multi-port configurations for camera and other high-bandwidth automotive applications. High-performance up to 9 GHz with secure and easy mating and unmating.



### FAKRA Connectors

Color-coded and mechanically keyed for easy installation and to prevent mismatching, the FAKRA interface is available in IP67 and non-IP67 PCB and cable-mount configurations designed to perform up to 6 GHz. Commonly used in compute modules, wire harnesses and camera applications.



### cStack™

**CUSTOMIZABLE SOLDERLESS INTERPOSER-BASED ONE-PIECE STACKER** The Amphenol cStack™ high speed solderless interconnect solution provides limitless flexibility for board-to-board mezzanine applications and board-to-board stackable and coplanar applications.



### TR Multicoax

**Highest Density High Speed Coax Connector** TR Multicoax delivers superior signal integrity from multiple high speed analog or digital channels. With a choice of 20GHz, 40GHz, or 70GHz configurations, users can upgrade their connectors according to bandwidth requirements on their application.



### Smart Antenna Interconnect

Consolidates wireless functions into a single module that utilizes custom RF products to enable the mounting of these modules directly to external vehicle antennas. Ruggedized for use in automotive environments against mechanical and environmental stresses.



### Camera Module Interconnect

Custom camera backs and high-float blindmateable internal interconnect connect high bandwidth camera modules used for ADAS, 360 surround view and safety applications. External connectivity options include FAKRA, Mini-FAKRA and pre-terminated cable with an overmolded strain relief.



### FAKRA to AMC/AMC4 Cable Assemblies

FAKRA to AMC and AMC4 assemblies combine the automotive industry-standard FAKRA connector with the ultraminiature AMC or AMC4 connectors on micro-coax cable. Ideal for tight spaces, these configurations are commonly used to connect cameras, antennas, sensors or other devices in the cab of a vehicle. Custom solutions are available.



### FAKRA to FAKRA Cable Assemblies

FAKRA to FAKRA assemblies are used to connect cameras, antennas, sensors and other devices to a vehicles ECU or compute modules. Standard configurations feature straight and right-angle FAKRA plugs and jacks terminated to RG-174 or RG-58 low loss cable. Custom FAKRA cable assemblies and harnesses are available in any configuration utilizing a wide array of automotive cable types.

# Automotive SAA Automotive Antennas

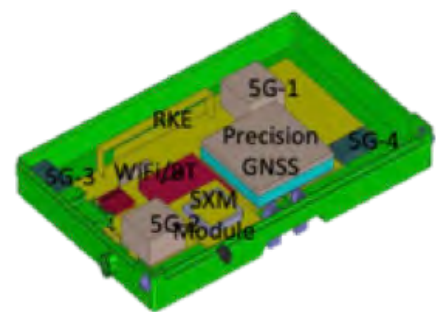

## Smart antenna Modules

- Receiver / Tuner next to Antenna
- MIMO Antenna
- Digital communication HSD /
- Ethernet

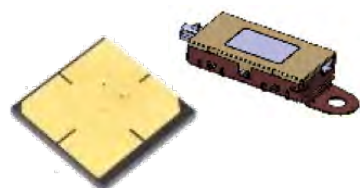

## Passive and active antenna components

- Amplifier LNA
- Switches / Gateways
- Multiplexer / Splitter

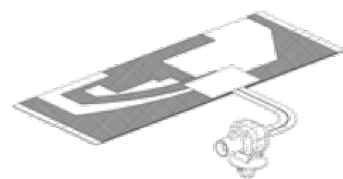

## Antenna wiring solutions

- FAKRA / Coax
- HSD
- Ethernet

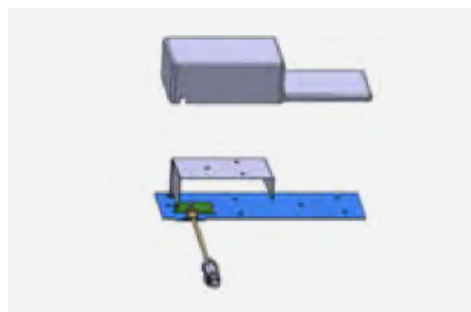

## Data Communication

- GSM to LTE / Future 5G
- Telematic Data



## Comfort and Safety: Low Frequency – Short range

- Bluetooth / WIFI
- Wireless Charging
- Keyless Entry
- TPMS



## Broadcast / Infotainment

- Satellite Radio SDARS
- Television UHF/VHF
- Glass Antennas
- FM / AM Radio
- DAB Radio
- DTV



## Autonomous Driving

- GPS / Glonass / Galileo
- Precision GNSS Recognition
- Car 2 X communication
- Traffic data broadcasting

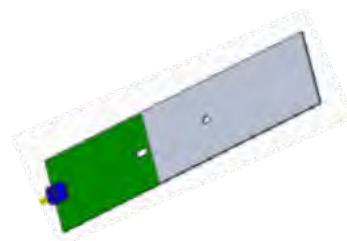

## Remote Controlled Functions

- Keyless Entry
- Remote HVAC Control
- Vehicle Pre Condition



## Hidden 5G



## Transparent Antenna



## V2X



## LTE/WIFI



## Spoiler Ant AM/FM/DAB



## AM/FM LNA



## Battery coil

## AM/FM/DAB Printed on glass

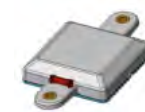

## Battery coil



## GPS



## V2X Compensator



## NFC/Reader



## V2X Antenna



## Sharkfin Antenna 5G,GNSS,V2X,WIFI



## Battery coil



## BT/UWB Module

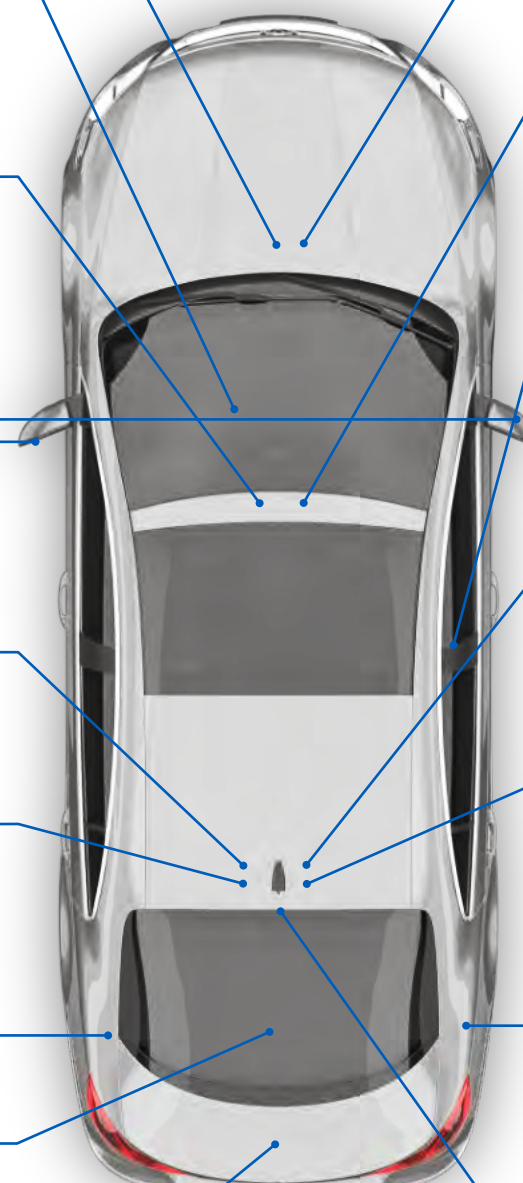

# ACCELERATE EV Infrastructure

with Amphenol Charles Industries

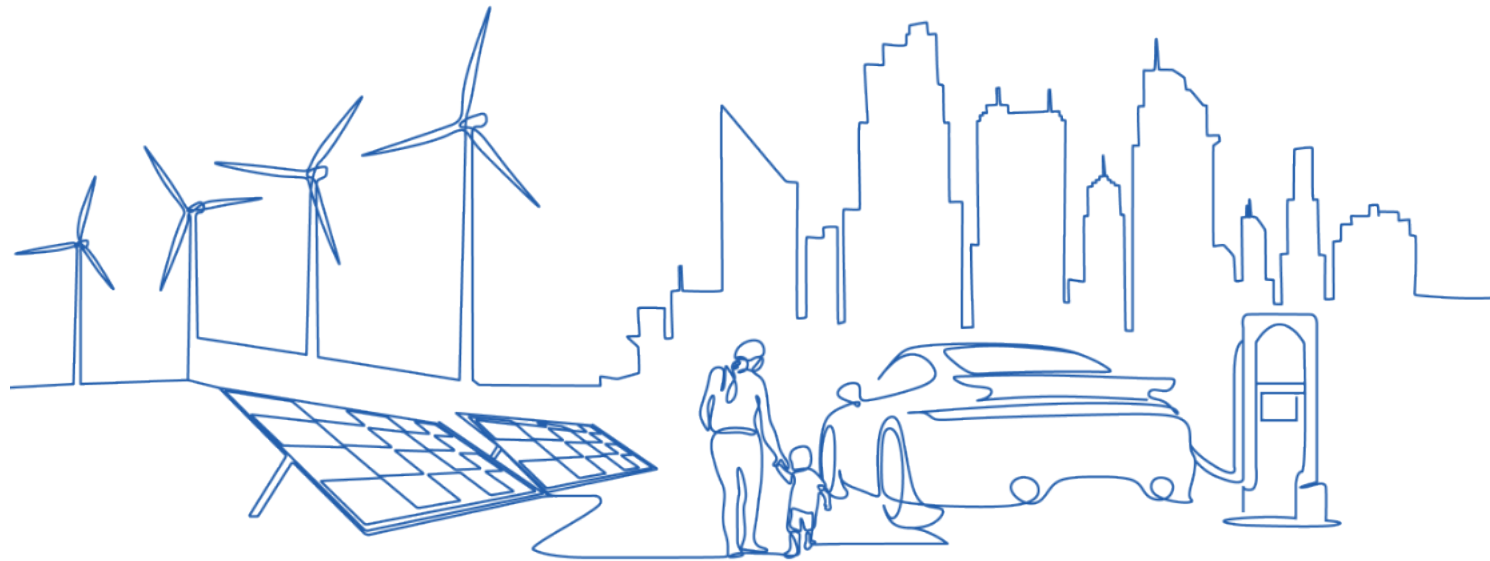

## Future forward with *Fast-Tracked EV* adoption

With climate change becoming an increasing area of concern, the US federal government has turned its focus to improving air quality, with a goal of achieving net zero greenhouse gas (GHG) emissions by 2050. Automobiles account for nearly one-fifth of these emissions, so a key driver to reducing emissions is a transition to greater use of electric vehicles (EV). Deploying EVs to government employees will go a long way towards achieving this goal.

Even without this added commitment to EVs, EV sales to individual consumers in the United States have climbed by more than 40% each year on average since 2016.

One of the top concerns among US consumers regarding EVs is the nation's limited network of battery charging stations and charging issues. To keep EVs powered up requires setting up public charging stations that need to be economical, equitably distributed, appealing to use, and wired to a robust power grid.

Amphenol Charles offers a competitive edge to companies that want to help this emerging market and provide reliable solutions that can be deployed rapidly and efficiently. Also, with the nation experiencing significant labor challenges, Amphenol Charles' products and solutions enable more deployments with limited resources.

<p><b>50+</b></p> <p>years of experience in manufacturing innovative enclosed solutions</p>	<p><b>20M+</b></p> <p>enclosures deployed for various markets</p>	<p><b>24/7</b></p> <p>Technical Customer Service available</p>	<p><b>1000+</b></p> <p>products to choose from and can be customized to fit your needs</p>
---	---	--	--

The Electric Vehicle Charging Infrastructure Market Size is expected to reach at USD 182.9 Billion by 2030, registering a CAGR of 30.2%, owing to rising adoption of Electric Vehicles. China and Germany are at the forefront of the transition to electric mobility. China was the leading country for the technological development of electric vehicles, whereas Germany scored the highest in current customer demand. The US and Canada combined have around 55,000 level 2 and DC fast-charging public stations. This number is far from future anticipated needs.

Ultimately growth in EV sales will warrant a network of publicly accessible fast chargers to:

- Enable longer trips in an EV
- Encourage buyers who lack access to private charging to consider an EV
- Tackle range anxiety as a barrier to EV adoption

## Simplified EV Infrastructure solution from Amphenol Charles Industries

With the EV adoption gaining momentum, the government faces never-ending challenges ranging from supply chain issues, massive electricity demand, investment in costly hardware, planning, and installation costs, estimated to be more than \$35 billion throughout 2030. Amphenol Charles Industries' communication and network, energy storage, enclosures and rapid installation solutions can significantly reduce time and cost. Let's explore how:

## EV Charging Back & Front End Infrastructure

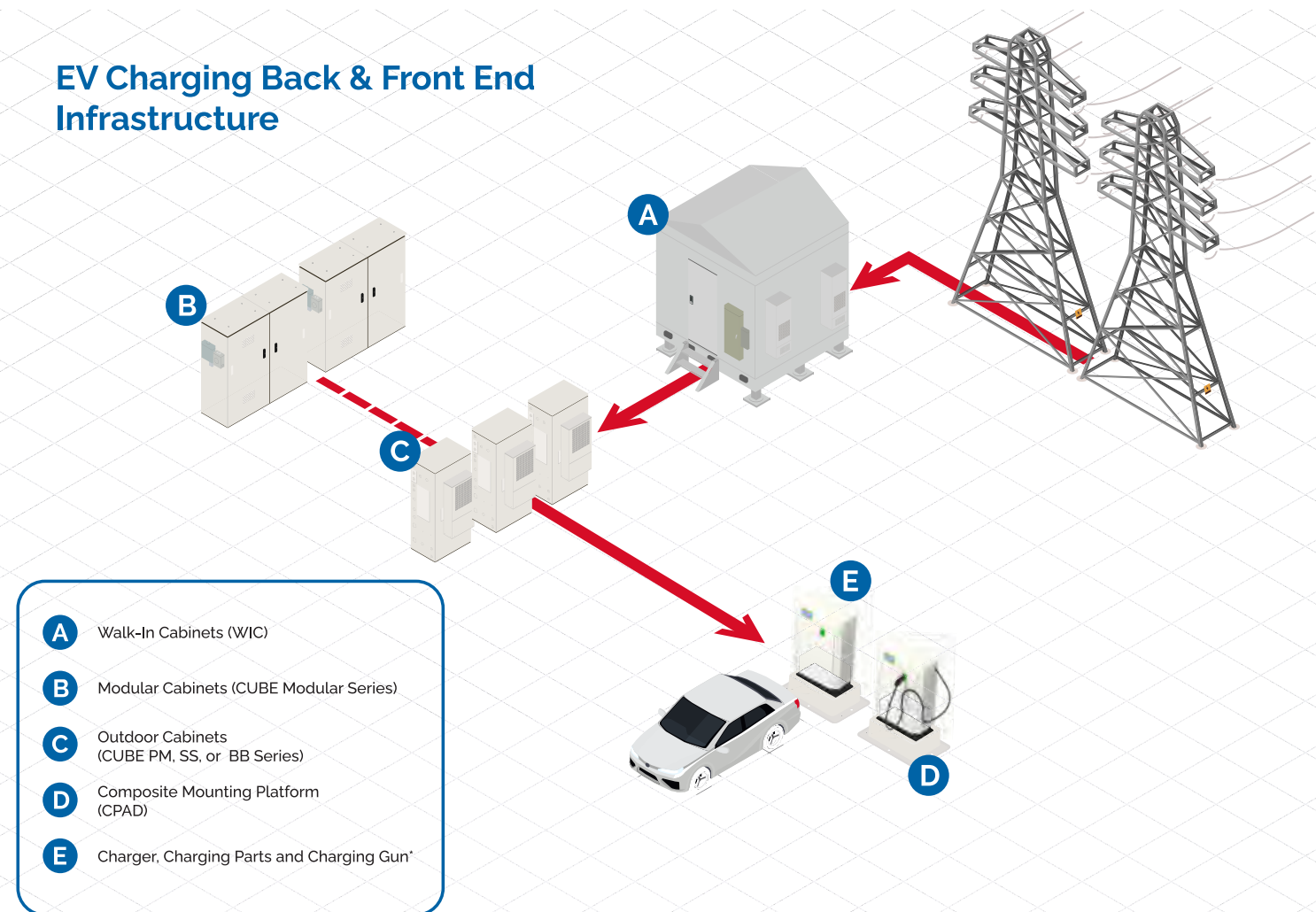

\*Charger parts include but not limited to Busbars, HV orange jumpers, Terminal blocks, Communication connectors (M12/Ethernet), Cable harness, and more. Wide variety of EV Charging Guns and Inlets are available.

## The Amphenol Charles Solutions

### Energy Storage & Communications Solution



#### Walk-In Cabinet WIC

The Walk-in Cabinet (WIC) is designed for remote base stations as an energy efficient, cost-saving alternative to concrete shelters and huts. The WIC offers ample space for customer installed equipment. It includes the exclusive Charles Thermal Management System (CTMS) and the Intelligent Ventilation System (IVS), which carefully regulate the interior temperature to ensure optimal performance.

### Energy Storage & Communications Solution



#### Modular Cabinets CUBE Modular Series

Our series of Modular Cabinets (MC) offer the most versatile solution for outdoor deployments. The cabinet consists of multiple standard bays that can be mixed and matched into any configuration needed for an application. Specify the number and types of bays needed, as well as the power system, thermal unit and many other options.

### Communications Solution



#### Pad Mount Equipment Cabinets CUBE PM Series

The CUBE-PM series enclosures are designed for high density installations of network equipment in outdoor environments. Easily mounted on a concrete or composite pad.

### Rapid Installation Solution

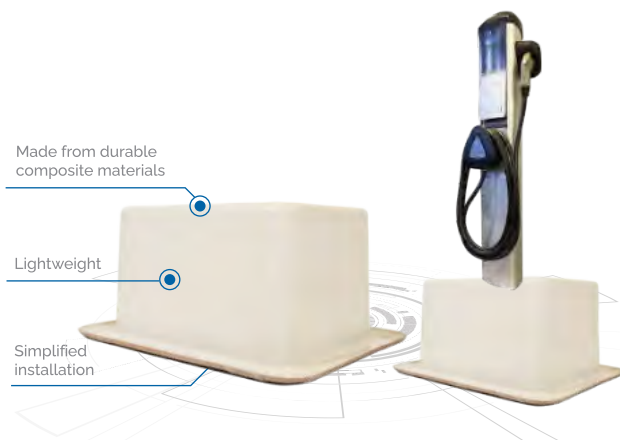

#### Composite Mounting Platform CPAD

Charles Composite Pads (CPAD) are economical alternatives to poured-in-place or precast concrete pads. They reduce time and labor at the time of installation. CPADs can be deployed in a single day, vs. waiting for a new concrete pad to be poured and cured.

## About Amphenol Charles Industries

Founded in 1968, Charles Industries, LLC is a manufacturing and technology company based in Schaumburg, Illinois with five U.S. and two Mexican manufacturing centers. We offer a comprehensive line of active and passive, metallic and non-metallic environmental enclosure solutions for communications and power distribution applications.

Supplying telecommunications, wireless, broadband cable, utility, and industrial markets worldwide, we're proud of our Midwest manufacturing roots that strengthen our position in an ever-changing marketplace.

In April 2019, Charles was acquired by Amphenol Corporation, a world leader in the antenna, optics and interconnect solutions with over 74,000 employees worldwide. Today, Charles operates as an Amphenol Company and is leveraging Amphenol's global resources and innovative technologies to create new, bundled solutions for our customers.

We offer the following:

- Cabinet & Enclosures
- Concealment & Pole Solutions
- Pedestals & Housings
- Fiber Optic Solutions
- Below Grade Enclosures

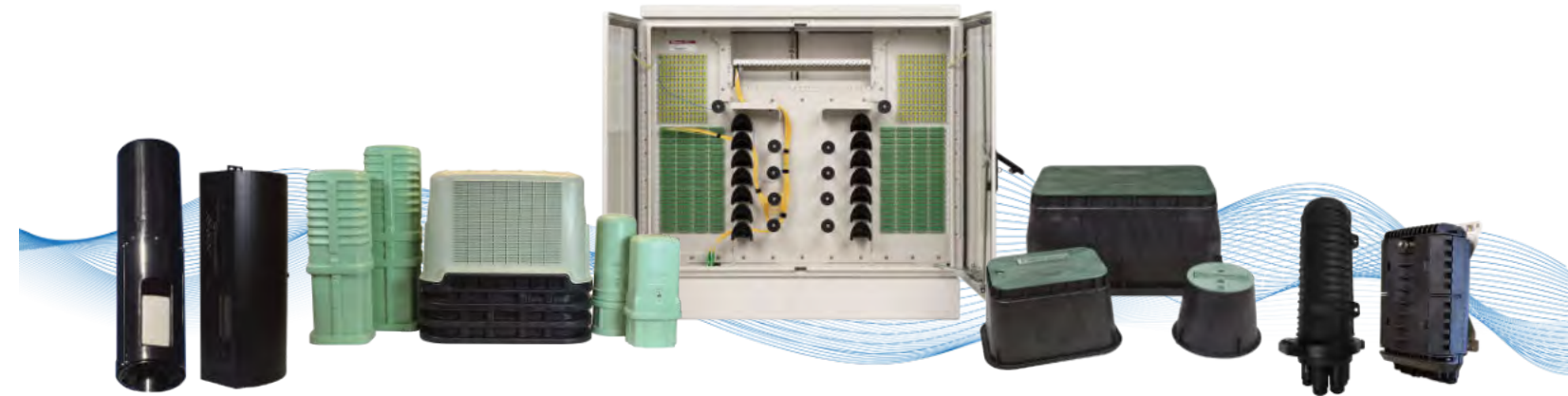

Protecting the connections that bring people together

Visit [www.charlesindustries.com](http://www.charlesindustries.com) to see our full line of products

©2023 Charles Industries, LLC • All Rights Reserved • Specifications Subject to Change



Sources: America's electric-vehicle charging Infrastructure-McKinsey & Company- April 18, 2022 | EY E-Mobility Power Sector Brochure- June 2022, EY | Acumen Research and Consulting: October 09, 2022

# APPLICATION SCOPE

# Consumer

Amphenol is ready with excellent interconnect solutions that are capable of operating precisely and efficiently to meet the new levels of connectivity and convenience over a wide range of consumer applications.

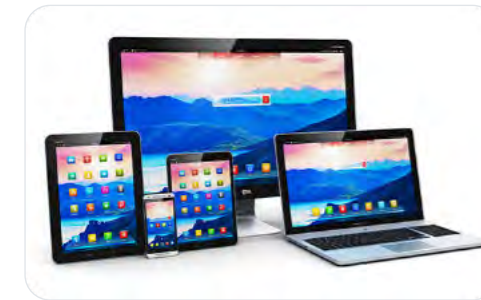

## Desktop / Notebook Computers

Amphenol has a track record in supplying the right choice of connectors addressing various components of a desktop computer including Motherboards, power supply units, storage. Also provides a range of connectors suiting the battery management, trackpad, high def cameras, USB4 connectors and storage drives of powerful Notebooks.



## Power Tools

Amphenol provides a choice of connectors to charge up battery-operated cordless power tools like drills, jackhammers, saws, and sanders.



## Personal Care Products

Amphenol has an array of compact, high performance Input Output, Board-to-Board and Wire-To-Board solutions that service the PCBs, power supply units, and motors of these devices so that they keep us satisfied with the highest quality, precision, and perfection.



## Home Appliances

To meet next generation smart home requirements, Amphenol connectors are designed to support increasingly sophisticated home appliances requiring integrated features like wireless connectivity and sensing capabilities.

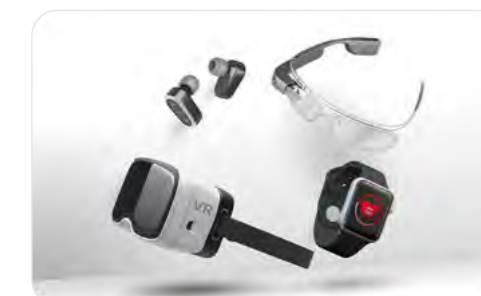

## Wearables

Amphenol's focus on innovation enables us to provide our customers an array of miniature, high performance interconnect solutions for next generation wearable devices.



## E-Bikes

E-bikes set standards for the next generation light-mobility, with safer, greener, and comfortable rides. Amphenol provides high power and reliable battery support that ensures uninterrupted performance for longer durations.



### PCIe® M.2 Gen 5 and Gen 4

- 67 contacts on 0.50mm pitch fully compliant with PCI-SIG PCIe® M.2 specification
- Dual Stacked, Shielded versions are available
- Right angle, vertical and various connector heights and keying options offered



### PSAS, SAS and SATA Connectors

- SAS connectors (29-pins) support hot plugging and blind mating of HDDs/SSDs, 2 signal lanes support up to 24Gb data rate (SAS 4.0).
- PSAS connectors (68pins) support SAS HDD and NVME SSDs with 2 SAS lanes supporting up to 24G data rate and 4 PCIe lanes supporting up to 32G (PSAS 5.0) data rates.



### DisplayPort 2.1 Connectors

- DP2.1, UHBR20, 80Gbps/4 Lanes, 85ohm, for DP80 cable
- Backward compatible to DP1.4 footprint.
- Optional for flange and plastic post.



### DDR5 SO-DIMM Connectors

- 262 positions connector in high-density design of 0.50mm pitch
- 4.00mm, 8.00mm, 5.20mm and 9.20mm height
- Right angle and vertical orientation with SMT mechanical hold-downs



### USB Type-C Connectors

- Performs to USB4 and Thunderbolt4 high-speed specifications, and backward compatible with USB3.2 Gen1 and Gen2
- Waterproof versions featuring unique O-ring technology (LIM) perform up to IPX8
- Supports up to 240W (5A/48V) power supply

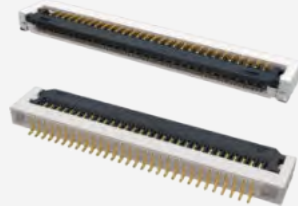

### FFC/FPC Connectors

- From 0.21mm to 2.0mm pitch with various heights ranging from 0.5mm to 6.25mm.
- Easy to operate and high vibration-proof performance
- Automotive grade versions compliant with USCAR2 and LV214 are available
- FFC cable can be supported as a whole solution



### Compression, Board to Board Connectors and Interposer

- Provides a connection between either two PCB modules or one PCB and an electrical module
- Single-piece compression-type or two-piece board-to-board surface mount connectors



### SD/Micro SD Express Series Connectors

- PCIe Gen3\*1/ Gen4\*1 lane
- Backward compatible to UHS-I/UHS-II in one socket (3-in-1 solution)
- Push push/push pull structure



### Power Connectors

- Wire to Board connectors in 3.0 mm and 4.2mm pitch with current ratings from 6.5A to 20A per pin
- Designed for IT and Datacom applications



### Minitex® Pwr Connector and Cable Assemblies

- Complete interconnect solutions for wire-to-wire and wire-to-board
- Available in pitch sizes of 3.00mm, 4.20mm and 5.70mm
- Current ratings from 5A to 28A



### ComboStak® 0.80mm / 2.00mm

- Hybrid and medium power solution
- 0.8A signal, 20A power
- Signal speed up to 12Gb/s.

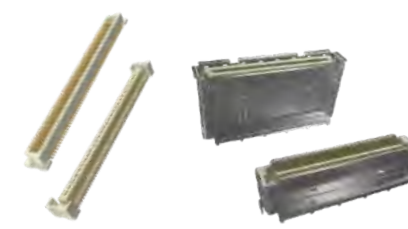

### BergStak® 0.80mm

- Ideal for use in high density applications
- Wide range of positions and stack heights
- Speed up to 16 Gb/s.



### Custom Battery Pack Connectors

- Robust battery pack charger connectors and terminal solutions for cordless power tools, lawnmowers, cordless vacuum cleaners, and personal care devices
- Available in various pin configurations and connector sizes with current ratings up to 45A.
- IP67 rated in both mated and unmated condition

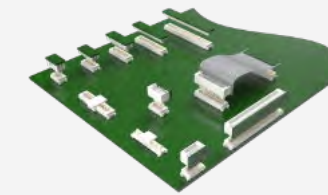

### Conan® 1.00mm

- Secure, reliable connector
- Audible "click" to ensure perfect mating
- Speed up to 8 Gb/s.



### Micro Board-to-Board

- Low profile and fine pitch for high density applications
- High current rating (Up to 5A)
- Chamfer connector design prevents mismatching

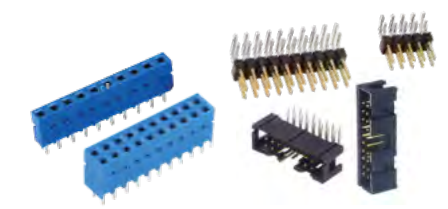

### Modular Systems 2.54mm/2.00mm

- Dubox®, Quickie®, BergStik®, PV® 2.54mm, Minitex® 2.00mm
- Industry proven connector system
- Board to Board, Wire/Cable to Board

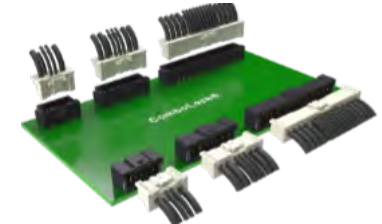

### ComboLock® 1.00mm/3.00mm

- Compact, hybrid wire-to-board connector.
- Active Positive Latching
- 1.5A signal, 10A power



### Customized Solutions for Automotive and Consumer Applications

- Supports custom connector requirements with value-added solutions, minimal turnaround time, and competitive pricing



## Consumer



### Lynx™

**HIGH SPEED AND DOUBLE DENSITY LOW-PROFILE BOARD-TO-BOARD CONNECTOR**  
Amphenol's Lynx™ is a 4-row product offering doubling the density in a 2-row footprint that is suitable for a wide variety of applications in datacom, enterprise server, industrial, medical and more.



### TR Multicoax Connector

**HIGHEST DENSITY HIGH SPEED COAX CONNECTOR**  
Delivers superior signal integrity from multiple high speed analog or digital channels using patented solderless, compression mount technology. With a choice of 20GHz, 40GHz, or 70GHz configurations, users can upgrade their connectors according to bandwidth requirements on their application.



### Lynx™ QD

**THE QUAD DIFFERENTIAL SOLUTION**  
Optimized for differential pair signaling, Lynx™ QD sets a new standard for density and flexibility that offers an innovative, high performance interconnect with PCIe® Gen 5 support. Lynx™ QD supports data rates of 56 Gb/s PAM4.



### cStack™

**CUSTOMIZABLE SOLDERLESS INTERPOSER-BASED ONE-PIECE STACKER**  
The Amphenol cStack™ high speed solderless interconnect solution provides limitless flexibility for board-to-board mezzanine applications and board-to-board stackable and coplanar applications when terminated to a flex circuit.



APPLICATION SCOPE

# Data Centers

Amphenol provides a wide range of the most advanced interconnect solutions for modern Data Centers and all their components.



## Storage

Amphenol has a robust portfolio of high performance, reliable connectors that are ideal for Data Center storage systems. Amphenol provides a wide range of the most advanced interconnect solutions for modern Data Centers and all their components.



## Rack Connectivity

Check out Amphenol's connector and cable solutions including Transceivers, Active Optical Cables, and High Speed External I/O Cable Assemblies that are perfect for consistent high speed rack connectivity.



## Server / Switch Router

Amphenol offers many interconnect solutions like High Speed I/O Connectors, Board-to-Board and Wire-to-Board Connectors, Memory, Media, and Peripheral Connectors, Modular Jack and USB solutions, and SATA and SAS Storage Connectors, which help in the flawless performance of these systems.



## Power Distribution

Amphenol's high density power connectors, bus-bar interconnects, and cabled solutions effectively enable these power distribution units to help power up the entire Data Center.

## Data Centers



### PCIe® Flip CEM, Slim CEM, Direct Cable Solution

- Flip CEM with "JJ" contact or "LL" contact provides better support for card edge to save keep out area for routing as compared to standard PCIe CEM contact of "JL".
- Standard PCIe CEM footprint is 8.2mm, Slim CEM is 7.45mm, Flip CEM is 5.9mm
- Direct Cable CEM features high-speed signal pins that directly attach to cable ends to save PCB loss



### PCIe® Gen4 and Gen5

- X1, X4, X8, X16, X24, X32 standard links
- 1.00mm pitch, vertical and right angle with options for ridge, locked latch, side latch, blade hold down, open wall
- Extensive range include options for surface mount, through-hole solder, press-fit and straddle mount terminations and keying options offered



### BergStak® Secure 1.00mm

- High security, high density
- EMI Shielding
- Speed up to 32Gb/s.



### Mini Cool Edge for GENZ/EDSFF/OCF

- 0.60mm pitch connector, supports high speed up to 112G PAM4
- Designed to meet SFF TA1002, Gen Z, EDSFF, OCP NIC 3.0 specifications
- Vertical, right angle, straddle mount and orthogonal options are available



### DDR SMT Memory module Connectors

- Designed to meet JEDEC SO-016, SO-017, SO-019 and SO-023 specs
- U DIMM/R/LR Socket, Metal tab, Standard/Narrow/ latch available

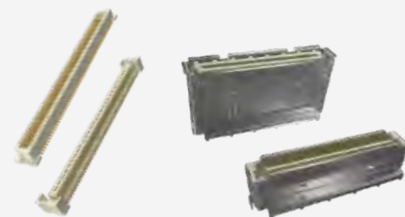

### BergStak® 0.80mm

- Ideal for use in high density applications
- Wide range of positions and stack heights
- Speed up to 16 Gb/s.



### Double Density Cool Edge for Ultra Compact Design

- 0.80mm pitch, power and signal hybrid connector
- Highly configurable wafer design for differential, single-ended and power options
- Supports high speed of up to 32GT/s(or 56GT/s PAM4) capability



### PSAS, SAS and SATA Connectors

- SAS connectors (29-pins) support hot plugging and blind mating of HDDs/SSDs, 2 signal lanes support up to 24Gb data rate (SAS 4.0).
- PSAS connectors (68pins) support SAS HDD and NVME SSDs with 2 SAS lanes supporting up to 24G data rate and 4 PCIe lanes supporting up to 32G (PSAS 5.0) data rates.

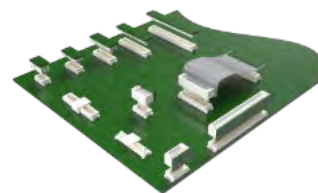

### Conan® 1.00mm

- Secure, reliable connector
- Audible "click" to ensure perfect mating
- Speed up to 8 Gb/s.



### Mini Cool Edge IO

- Up to 64Gb/s PAM4, PCIe® Gen 4, PCIe® Gen 5, PCIe® Gen 6, over 1.0 meter transmission distance
- 0.60mm pitch connectors support both cable and card edge connections
- Options for 92Ω, 85Ω and 95Ω impedance and various pin number options - meeting PCIe®/NVMe/SAS/SFP(+)/QSFP specifications



### ExtremePort™ Z-Link

- Compliant with Gen-Z and OCP NIC specifications, SFF-TA-1002/1020 solution
- High speed of up to 56Gb/s PAM4
- Supports both cable and card edge applications



### RJMG

- 10/100T, 1GBT (10/100/1000-BT), 2.5G, 5G, 10G, Power Over Ethernet (PoE, 15W-150W), integrated with surge protection.
- Commercial 0-70°C and industrial -40-85°C & -40-105°C.
- Meets IEEE802.3ab and supports various Ethernet PHY



### Multi-Trak™

- Combines original PCIe® and Mini Cool Edge IO in one connector to provide both power (21A) and high/low-speed signal
- Up to 56Gb/s PAM4, PCIe® Gen 5, and target PCIe® Gen 6
- Options for 85Ω impedance and various pin number options - meeting PCIe®/NVMe/SAS/OCF DC-MHS/ SFF-TA-1033 specifications



### Fan Connectors

- Blind-Mate Interface Wire to Board connectors from 1.25mm to 2.54mm pitch with max current rating 5.5A/pin. Designed for Server and Storage applications
- Card to Wire connectors in 2.44mm and 2.54mm pitch with current rating 4A/pin. Designed for Switch application

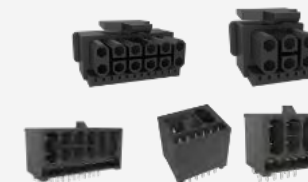

### Minitek® PICPwr OCP Connector Solutions

- Newly launched 12V connector solution supports Open Compute Project Power Distribution and Management architecture requirements
- Operating power and voltage is 864W at 12VDC



### ExtremePort™ Swift

- Ultra-low profile, 0.60mm pitch connector in 8X, 16X configurations. Mating height 8.38mm
- Designed for unshielded, internal I/O connectors
- With 85Ω impedance and meets PCIe® Gen 5 NRZ 32G specifications



### Power Connectors

- Wire to Board connectors in 3.0 mm and 4.2mm pitch with current ratings from 6.5A to 20A per pin
- Designed for IT and Datacom applications



### Minitek® Pwr CEM-5 PCIe® Connector System

- Newly launched CEM 5.0 PCI Express® 12VHPWR auxiliary hybrid connector and cable assembly solution
- Supports 600W GPU cards
- Rated current up to 9.5A per contact and features fully isolated terminals

## Data Centers



### BarKlip® BK500 IO

- Distributes up to 500A per contact
- Simple configurable plug-and-play solutions
- Fully compliant with ORv3 Power Output Specifications



### PwrBlade® Mini Cable-to-Board Connector

- Rated up to 25A per power contact (50A/column) without exceeding 30°C temperature rise in still air
- Modular tooling design
- 12AWG for power contacts and 26AWG-22AWG available for signal contacts



### PwrBlade® ULTRA HD

- Up to 85A per contact
- 2.0mm high density signal pitch
- Ultra-low profile height of 9.6mm above board for optimized airflow



### BarKlip® BK150 IO

- Distributes up to 150A per contact between busbars, cables, and circuit boards
- Simple configurable plug-and-play solutions
- Fully compliant with ORv3 IT Gear Power Input Solution Specifications



### PwrBlade® Mini Board-to-Board Connector

- Rated up to 45A per high power contact (4 adjacent contacts)
- Low profile 8.10mm height above board
- Modular tooling designs



### PwrBlade® IO

- Up to 60A per contact (high power) & 25A per contact (low power)
- Power & signal contacts are highly configurable
- Wide range of wire sizes available



### AC Input Connector and Cable Assemblies

- 7-Pin connector designed for Star, Delta, and single-phase connections
- Simple configurable plug-and-play solution designed to meet various current and voltage ratings
- Fully compliant with OCP ORv3 Power Shelf Universal Input Connect Specifications



### PwrMAX® I/O Cable Connector System

- Rated up to 50A/Contact (100A/column) without exceeding 30°C temperature rise in still air
- Latching options available
- Patented GCS® and GXT® plating



### BarKlip® XP300/ XP200

- Current ratings up to 300A and 200A
- Mates with 3.0mm busbar
- ±2.0mm gatherability



### CoolPower® SDM

- Up to 35A per pin, high current Coolband contact technology
- Backplane, coplanar, and orthogonal configurations available
- 2 position or 4 position available

## Data Centers High Speed

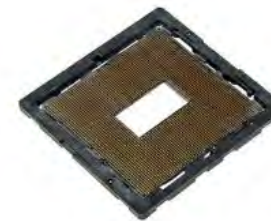

### cLGA® Land Grid Array Socket System

**HIGH PERFORMANCE, LOW COST CHIP-TO-BOARD APPLICATION**  
Designed to bring conventional connector material construction to high performance, low cost chip-to-board applications. Used in applications ranging from handheld computer products to supercomputer systems.



### EnergyEdge™ X-treme

- 3000W at 12V
- Available in straddle mount, right angle, right angle coplanar, and vertical configurations
- 25% increase in current linear density

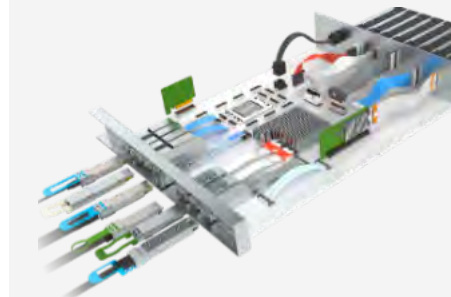

### OverPass™ Cable System

**INDUSTRY-LEADING DIRECT HIGH-SPEED INTERCONNECT**  
Amphenol's OverPass™ cable system offers a broad range of capabilities that allow our customers to efficiently transmit high speed signals from near an ASIC to anywhere in their system.



### PwrMAX® G2

- Highest density blind-mate Power and Signal connector series
- Up to 130A per contact and 18% size reduction
- Orthogonal, mezzanine, coplanar and right-angle configurations available for both PCB and busbar applications



### M-Series 56 Mezzanine Connectors

**56GB/S HIGH SPEED MEZZANINE BGA CONNECTOR SYSTEM**  
Leveraging proven technologies, including an industry leading BGA design, offering superior self-aligning and self-leveling. With a next generation differential pair contact design for up to 56Gb/s NRZ and 112Gb/s PAM4 performance.

Data Centers  
**High Speed**



**ExaMAX®**

COST OPTIMIZED WITH SCALABLE PERFORMANCE TO 112G PAM4  
Innovative design supports low insertion/extraction forces with reduced crosstalk and low insertion loss. Flexible architecture supports direct orthogonal, traditional backplane, coplanar and cable requirements.



**InfinX Mezzanine Connectors**

OPTIMIZED FOR PERFORMANCE AND DIFFERENTIAL PAIR SIGNALING  
The InfinX® high-speed mezzanine connector solution is designed to meet the needs of 25+Gb/s applications. Available in 4- and 6-Pair configurations, InfinX is your best choice for high speed board-to-board applications.



**QSFP28 Active Optical Cable**

HIGH PERFORMANCE, PLUG AND PLAY INTERCONNECT SOLUTIONS  
Amphenol's 100G QSFP28 to QSFP28 Active Optical Cable assemblies are a reliable, cost and power efficient, integrated solution which is ideal for high density signal transmission.

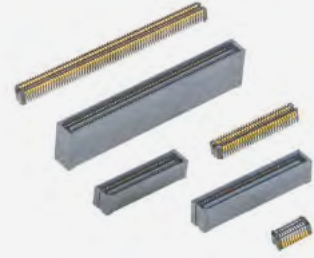

**Lynx™**

HIGH SPEED AND DOUBLE DENSITY LOW-PROFILE BOARD-TO-BOARD CONNECTOR  
Amphenol's Lynx™ is a 4-row product offering doubling the density in a 2-row footprint that is suitable for a wide variety of applications in datacom, enterprise server, industrial, medical and more.

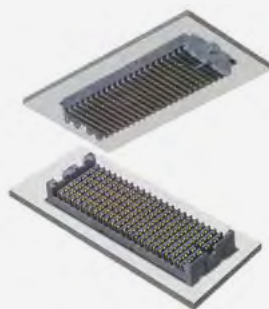

**Chameleon®**

ADAPT AND ADVANCE TO THE NEXT GENERATION  
With performance speeds up to 25 Gbps+, Chameleon meets the demand for faster, smaller and more compact connector solutions. Chameleon delivers a new level of performance unlike any other platform connector on the market today.



**Mini-SAS HD Active Optical Cable**

RELIABLE HIGH PERFORMANCE INTERCONNECT SOLUTION FOR MSAS APPLICATIONS  
Amphenol's Mini-SAS HD Active Optical Cable is fully compliant to SAS 2.1 and SAS 3.0 industry standards as well as the SFF-8636 interface standard. Used primarily for external Enterprise storage applications.



**Lynx™ QD**

THE QUAD DIFFERENTIAL SOLUTION  
Optimized for differential pair signaling, Lynx™ QD sets a new standard for density and flexibility that offers an innovative, high performance interconnect with PCIe® Gen 5 support. Lynx™ QD supports data rates of 56 Gb/s PAM4.



**Paladin HD®**

DENSITY OPTIMIZED PERFORMANCE BEYOND 112G PAM4; ROADMAP TO 224G  
Achieves 144 diff pairs within 1U Orthogonal slot. Consistent signal integrity performance over the entire mating range. Flexible architecture supports right angle female, direct orthogonal, and cables up to 12P.



**Paladin®**

SUPPORTS DATA RATES BEYOND 112G PAM4; INDUSTRY-LEADING SIGNAL TO NOISE PERFORMANCE  
Consistent signal integrity performance over the entire mating range. Flexible architecture supports direct orthogonal, traditional backplane, mezzanine, coplanar and cable requirements up to 8P.



**SFP28 25G Transceivers**

LOW POWER CONSUMPTION, HIGH SPEED, HIGH RELIABILITY  
Amphenol 25G SFP28 optical transceiver includes SR, LR Lite, LR, ER, etc. adopt LC interface and compatible with IEEE802.3by, Mainly applied in 25G Ethernet, CPRI10 and other environments.



**DensiLink® OverPass™ Assemblies**

112G DOUBLE ENDED HIGH PERFORMANCE CABLING INTERCONNECT  
DensiLink® OverPass™ products remove high speed signaling from the PCB and create a double ended, high performance cabling interconnect. These cables support 56G and 112G signaling in hardware system designs.

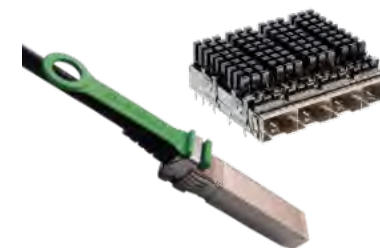

**SFP Connectors & Cable Assemblies**

SUPPORTS DESIGNS FROM 28G, 56G PAM4 Passive & active cables; 26AWG to 32AWG cable. Stacked, ganged and belly-to-belly board connector and cage configurations with heat sinks and light pipes. Available in all 4x form factors.



**QSFP28 100G Transceivers**

LOW POWER CONSUMPTION, DUAL RATE SUPPORT, HIGH SPEED AND HIGH RELIABILITY  
Amphenol 100G QSFP28 transceivers include SR4, CWDM4, LR4 and ER4 lite, adopt MPO or LC interface and compatible with IEEE802.3bm, SFF-8636 and other standards.



**OSFP Loopback 200G/400G**

200G / 400G SYSTEM CONFIGURATION SOLUTION  
Amphenol's OSFP (Octal SFP) Loopback Modules are part of our OSFP I/O system product family that includes copper cables, connectors and AOC's. These OSFP loopback cable assemblies are offered in four configurations.



**QSFP28/56/112G Connectors & Cable Assemblies**

SUPPORTS PER PORT DESIGNS FROM 100G, 200G AND 400G PAM4  
4 lanes per cable – 28G, 56G and 112G per lane capability. Passive & active cables; 26AWG to 32AWG cable. Stacked, ganged and belly-to-belly connector and cage configurations. Available in all 4x form factors.



**ExtremePort™ OSFP 112G Connectors & Cable Assemblies**

SUPPORTS PER PORT DESIGNS FROM 200G, 400G AND 800G PAM4  
8 lanes per cable – 28G, 56G & 112G per lane capability. Double the bandwidth per port vs. QSFP. Backwards plug compatible with QSFP28/56 optical transceivers. Available in all 4x form factors.



**QSFP DD Loopback 200G/400G**

200G / 400G SYSTEM CONFIGURATION SOLUTION  
Amphenol's QSFP DD (Double-Density) Loopback Modules are part of our comprehensive QSFP DD product family offering - cables, connectors and AOC's. These QSFP DD loopback cable assemblies are offered in four configurations.



**TR Multicoax Connector**

HIGHEST DENSITY HIGH SPEED COAX CONNECTOR  
Delivers superior signal integrity from multiple high speed analog or digital channels using patented solderless, compression mount technology. With a choice of 20GHz, 40GHz, or 70GHz configurations, users can upgrade their connectors according to bandwidth requirements on their application.

# APPLICATION SCOPE

## e-Mobility

From Residential to Commercial energy storage systems, Amphenol provides a wide variety of interconnect solutions for energy storage systems.



### Battery Management Systems

The battery is considered as the strategic component of any electric vehicle. All electric vehicles (EVs) are equipped with a Battery Management System (BMS) that intelligently controls the battery charge and protects it from operations beyond the safe limits.



### On-Board Charger

On-Board Chargers are an integral and built-in part of Electric Vehicles for interfacing with AC-based charging systems. The Alternating Current (AC) supplied by the charger passes through the cable to reach the OBC, which then converts it to DC to charge the EV battery under the supervision of the Battery Management System (BMS).



### Power Inverter and Converter

The power inverter/converter unit within an electric vehicle converts the high voltage DC energy from the battery to a multiphase AC current that helps to drive the traction motor. The EV power management system also comes with a converter that does the reverse function at times of regenerative braking.



### Cell Connection System

A Cell Connection System (CCS) is integrated into the top battery cover of the EV battery module to bring high-voltage connectivity as well as channel signals like temperature and pressure sensing information to the BMS.

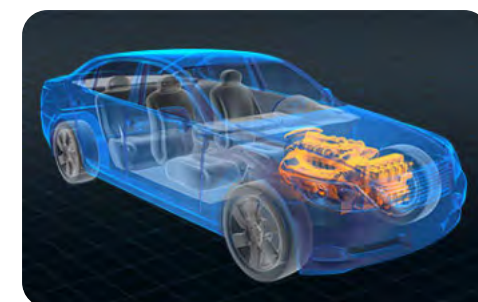

### Vehicle Control Unit

Vehicle Control Units (VCU) are considered the powertrain management system within an electric vehicle. They help with various functionalities of a vehicle from torque coordination, to gearshift operations, voltage management, and charging control.



### EV Charging

With a wide portfolio of power products supporting 15A-1000A ratings, low contact resistance, high thermal support and component modularity, Amphenol offers the most efficient solutions for the modern EV charging station.

## e-Mobility



### Ve-NET™ Multigigabit Differential Connector System

Automotive-grade Ethernet solution developed according to USCAR-2 & LV214, along with miniaturized and various sealed/non-sealed configurations. Featured high data rates up to 50Gbps per port and highly compact and robust to fulfill automotive applications such as camera systems, ADAS, and Autonomous Driving. Supports Automotive Ethernet, LVDS, APIX 3 PCIe and FPD4.

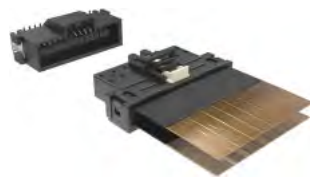

### FlexFast™ Flex to Board Connector Solution

Small size and low height flex to board connection solution. Compliant to USCAR2 and LV214 and designed for BMS, battery pack, Inverter+DCDC applications.



### Minitek MicroSpace™ High Voltage selective loaded Crimp-to-Wire Connector Platform

COMPACT, ROBUST AND VERSATILE CONNECTOR SYSTEM  
Minitek MicroSpace™ High Voltage selective loaded Crimp-to-Wire connector platform's unique design enables LV214 Severity-2 and performs at 3.81mm, 6.35mm, and 8.89mm pitch with 400V, 800V and 1200V.



### HSD (High Speed Data) Connector System

COMPLIANT WITH USCAR-2 SPECS  
HSD connector system is a fully shielded interconnect system that can be used with shielded twisted quad cables. It has a high performance digital system for low-voltage differential signals which prevents interference from crosstalk and external sources.



### FlexLock™ FPC-to-Board Connectors

MORE FLEXIBLE SOLDERING AUTOMOTIVE GRADE CONNECTOR SYSTEM  
USCAR-T2V2 and LV-214 S3 compliant with 2A per contact current carrying capacity and available in 10 to 30 position.



### Minitek MicroSpaceXS™ Waterproof 1.27mm Crimp-to-Wire Connector Platform

COMPACT, ROBUST AND VERSATILE CONNECTOR SYSTEM  
Crimp-to-Wire / Wire-to-Wire connector meets LV214 S2 and USCAR2-T2V2 specs, supports 4A/pin, and features TPA and CPA.



### NETBridge+™ Automotive Ethernet Connector System

USCAR-2 COMPLIANT AUTOMOTIVE ETHERNET CONNECTORS  
NETBridge+™ Automotive Ethernet Connector System is designed for automotive applications and can transmit up to 100Mb/s and 1Gb/s according to IEEE 100BASE-T1 and 1000BASE-T1 and will be upgraded to 10Gb/s.



### WireLock®

MORE RELIABILITY LOW MATING FORCE AUTOMOTIVE GRADE CONNECTOR SYSTEM  
WireLock® is a 1.80mm pitch wire-to-board and flex-to-wire connector system. Its compact design addresses the growing need for space-saving automotive-grade connectors.



### Minitek® Pwr 4.2 High Current Connector

ROBUST, VERSATILE AND HIGH CURRENT PERFORMANCE  
Minitek® Pwr 4.2 High Current Connector (HCC) is designed for power applications with current rating up to 13A per contact and wire gauge range from 30 to 16AWG for Wire-to-Wire and Wire-to-Board applications.



### 2.00mm FFC/FPC connectors with Autolock Mechanism

NON-ZIF FLEX CONNECTOR WITH AUTOLOCK  
LV214 S1 qualified non-ZIF flex connector with an autolock mechanism and surface mount termination.



### FloatCombo™ 0.50mm Floating Board-to-Board Connectors with Power Pin

HIGH SPEED HIGH CURRENT POWER PIN BOARD-TO-BOARD CONNECTORS  
USCAR-2 T3V2 qualified 0.50mm pitch floating BTB connector featuring 4 independent power pins with 5A current per pin and high-speed transmission of up to 16Gb/s.



### ComboStak® and PowerStak® Board-to-Board Connectors

HYBRID AND MEDIUM POWER SOLUTION  
ComboStak® and PowerStak® are compact, hybrid (signal and power) and power board-to-board connectors.



### 0.50mm and 1.00mm FFC/FPC ZIF Connectors

Right angle ZIF flex connectors with a front flip locking mechanism, surface mount termination, and double contact points. Features low profile height of 2.55mm.



### 0.80mm Floating Board-to-Board Connectors - B406/B407/B410 Series

HIGH SPEED BOARD-TO-BOARD WITH FLOATING MECHANISM  
Amphenol's B406/B407/B410 series are 0.80mm pitch floating board-to-board connectors which support stack heights up to 23mm and positions from 30 to 120.



### DuraEV™

PORTABLE AND FIXED BATTERY CHARGING AND DISCHARGING CONNECTORS  
DuraEV™ is a standard connector solution offered with 2 power and 4/6 signal pins which employs a patented contact system that is capable of carrying a continuous current from 15A up to 70A with 10,000



### 0.50mm FFC/FPC Connectors with Autolock Mechanism - F308/F332 Series

RIGHT ANGLE NON-ZIF FLEX AUTOLOCK CONNECTORS  
F308/F332 series is a 0.50mm pitch right angle Non-ZIF flex connector with an auto lock mechanism and surface mount termination. It features a height of 2.45mm and comes in 6 to 68 contacts.



### BergStak® 0.40mm Self-Alignment Board-to-Board Connector

USCAR-2 COMPLIANT CONNECTORS WITH SELF-ALIGNING FEATURE  
FCI Basics BergStak® 0.40mm self-alignment connectors come with a stack height of 3.50mm and 30 positions extendable up to 10 to 60 positions with 10 positions incremental.



### BarKlip® BK200 I/O for EV Charging

DIRECT PLUGGABLE CLIP THAT CONNECTS TO BUSBARS IN EV CHARGING STATIONS. Amphenol's BarKlip® BK200 I/O provides a convenient method of distributing up to 200A between busbars, cables and circuit boards. It features 14 fully independent cantilevered beams, providing a true compliant spring to adjust for variations in busbar alignment and surface finish.



### BarKlip® XP Connectors for EV Charging

HIGH POWER AND LOW RESISTANCE BUSBAR CONNECTOR FOR EV CHARGING STATIONS. Amphenol's BarKlip® XP connectors feature independent points of contacts that provide overall lower resistance and greater overall efficiency.



### PwrBlade+® Connector

NEXT GENERATION AC/DC POWER DISTRIBUTION CONNECTOR SYSTEM. AC/DC power distribution connector with 58A/contact without exceeding a 30°C temperature rise in still air.



### PwrBlade® Connector

The PwrBlade® power distribution connector system from Amphenol includes power and signal contacts to provide power distribution and power control in a single connector.



### PwrBlade® Cable Assembly

The PwrBlade® cable connectors are designed to mate to PwrBlade® right-angle or vertical board-mounted headers. By expanding beyond board-to-board applications, designers can now connect power supplies and power distribution subassemblies in a wider range of applications.



### PwrBlade+® Cable Connectors for EV Charging

PwrBlade+® cable connectors offer flexibility to meet a wide variety of customer needs. The connectors come in both Cable-To-Cable and Cable-To-Board solutions.



## e-Mobility

Amphenol provides a broad array of compact, robust, leading-edge interconnect solutions.



**Battery Management System**



**EV Charging**



**Power Inverter and Converter**



**Vehicle Control Unit**



**On-Board Charger**



**Cell Connection System**



## APPLICATION SCOPE

# Energy Storage Systems

From Residential to Commercial energy storage systems, Amphenol provides a wide variety of interconnect solutions for energy storage systems.



### AC-DC Inverters

The AC/DC Inverters or PCS (Power Conditioning Systems) work in conjunction with battery units for the smooth functioning of the Energy Storage System. Amphenol's enhanced power connectors and cable solutions are ideal for use in these systems.



### Battery Storage System

Amphenol offers compact, flexible high performing connectors that support Battery Storage systems within an Energy Storage System (ESS.)



### Battery Management System

Battery Storage, the key component of an Energy Storage System (ESS), is often equipped with a Battery Management System (BMS). From medium power wire-to-board connectors to board-to-board and card edge connectors, Amphenol has an extensive array of compact, reliable solutions that support BMS operation inside an ESS.



### ESS Controllers

An ESS Controller is used for efficient management of the battery modules in an Energy Storage System and manages charging, discharging of battery modules in addition to monitoring and controlling the environment temperature inside the ESS. It works alongside the BMS to collect and process data like voltage, current and fuse status. Through a CAN bus, these units maintain communication between battery racks and power conversion units of the ESS. Check out Amphenol's innovative connector solutions supporting ESS Controllers.



## Energy Storage Systems



### Minitek MicroSpaceXS™ Waterproof 1.27mm Crimp-to-Wire Connector Platform

COMPACT, ROBUST AND VERSATILE AUTOMOTIVE-GRADE CONNECTOR SYSTEM  
1.27mm pitch connectors with a current rating up to 3A per contact, making it ideal for higher power applications.



### ComboStak® and PowerStak® Board-to-Board Connectors

HYBRID AND MEDIUM POWER SOLUTION  
ComboStak® and PowerStak® are compact, hybrid (signal and power) and power board-to-board connectors, providing up to 20A per power blade and up to 12Gb/s signal speed.



### PwrBlade® Connector

NEXT GENERATION AC/DC POWER DISTRIBUTION CONNECTOR SYSTEM  
Rated up to 58A per power contact without exceeding a 30°C temperature rise in still air. Features an innovative high power contact design and housing that allows higher current carrying capability in a more compact package.



### WireLock®

MORE RELIABILITY LOW MATING FORCE AUTOMOTIVE GRADE CONNECTOR SYSTEM  
WireLock® is a 1.80mm pitch wire-to-board and flex-to-wire connector system with a nominal current carrying capacity of 2A and supports cable wire gauges from 22AWG to 26AWG.



### Minitek® Pwr 5.7 Connector System

5.70MM COMPREHENSIVE SOLUTION WITH CURRENT RATING UP TO 23A  
Features scoop proof housing to prevent damage to terminals, and polarized mating geometry to prevent mis-mating.



### PwrBlade® MiniMezz Connector Series

LOWEST PROFILE HYBRID MEZZANINE CONNECTORS  
Available in stack heights ranging from 8mm - 20mm with options for power & signal contacts. Modular tooling design to accommodate wide range of application requirements.



### FlexLock™ FPC-to-Board Connectors

MORE FLEXIBLE SOLDERING AUTOMOTIVE GRADE CONNECTOR SYSTEM  
FlexLock™ FPC-to-Board connectors come in a compact design and provide nominal current carrying capacity of 2A per contact to support higher power applications.



### Rugged USB 3.0

RUGGED USB CONNECTOR FOR HARSH ENVIRONMENT APPLICATION.  
Provides a great IP67 water/dust proof performance. Interface is sealed in both the mated and un-mated conditions.



### CoolPower® Slim Drawer

HIGH CURRENT CONNECTOR WITH COOLBAND CONTACT TECHNOLOGY  
Delivers up to 60A per pin and provides an ultra-low end-of-life contact resistance of just 0.40mΩ.



### FloatCombo™ 0.50mm Floating Board-to-Board Connectors with Power Pin

HIGH SPEED HIGH CURRENT POWER PIN BOARD-TO-BOARD CONNECTORS  
With 4 independent power pins supporting 5A current per pin in 0.50mm pitch, connectors are ideal for applications that need large current and space-saving. Provides a high-speed transmission performance of up to 16Gb/s.



### PwrBlade® Mini Cable-to-Board Connector

LOW PROFILE POWER & SIGNAL HYBRID CABLE CONNECTOR  
PwrBlade® Mini Cable-to-Board strengthens the PwrBlade® cable portfolio even further. Mini cable-to-board serves as an I/O cable configuration to meet the ever-increasing demand for higher current density in low profile applications.

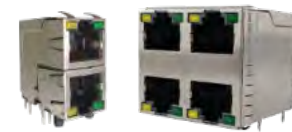

### RJ / Modular Jacks

- Cat5, Cat5e, Cat6, Cat6A
- Single port, ganged, stacked multi-port, LEDs, shielded
- Vertical, right angle
- PoE++ capability
- Industrial, commercial, medical, consumer, military applications

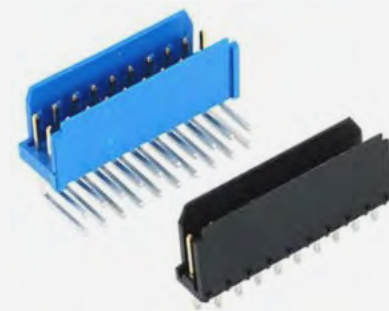

### Dubox® 2.54mm Crimp to Wire

The Dubox®, connector families offer an extensive range of through-hole and surface-mount part options, including single or double-row in either straight or right angle orientation from 2 to 50 positions, with a current rating of 3A (maximum) per individual contact.



### PwrBlade® Mini Board-to-Board Connector

LOW PROFILE POWER & SIGNAL HYBRID BOARD-TO-BOARD CONNECTOR  
PwrBlade® Mini Board-to-Board connector enhances Amphenol's existing PwrBlade® product line with the smallest profile to date. PwrBlade® Mini has an 8.10mm height above board, making it the lowest height power and signal board-to-board connector in the PwrBlade® portfolio.

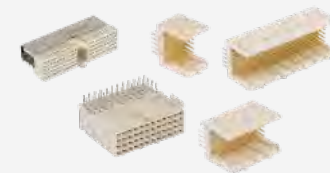

### Industrial Backplane Connectors

- 2.00 mm Millipacs® series hard metric connector, 2mm Metral® series future bus connector & 2.54mm DIN 41612 connector for robust applications in the Industrial segment
- Features 2-beam twisted tulip contact which provides an equalized signal path

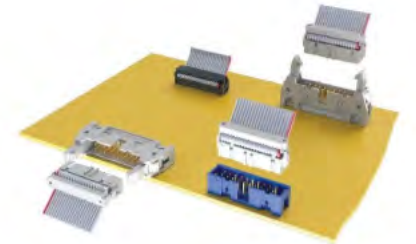

### Quickie® IDC Cable-to-Board Connector System

PRECISE AND DURABLE IDC CONNECTION WITH DUPLEX PLATING AND DUAL POLARIZATION  
Dual polarization feature prevents connector mismatching. Duplex plating saves cost and guarantees 100+ mating cycle performance.



### BarKlip® BK300 Connector

LOW RESISTANCE-HIGH POWER BUSBAR CONNECTOR  
The BarKlip® BK300 connector features 14 independent conducting beams that maintain contact with the mating busbar. These power beams provide lower overall resistance by maintaining contact with the mating busbar through common misaligned conditions.

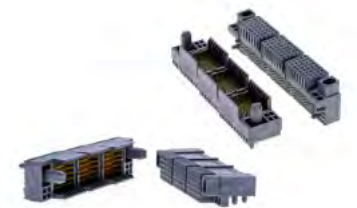

### Millipacs® Plus

- Configurable meeting designers' choice of signal data rates from 3Gbps to 25Gbps and power up to 40A and with multiple guiding options
- Compliant to Hardmetric equipment practice and complementary to 2mm Millipacs standard
- Options for Hotswapping, EMI shielding and high temperature

# APPLICATION SCOPE

# IoT

Check out Amphenol's wide range of high-speed, power efficient, rugged connectors supporting IoT technologies.



## Smart Home Automation Building Automation

With smart home automation, you can interact through your mobile device with any device or appliance in your home from anywhere. Control lighting and entertainment systems, manage security, surveillance, and more. Check out Amphenol's interconnect solutions today.

Building automation is a concept that targets centralized automatic control of all systems within a building from HVAC, lighting, security, elevators, AV communications, parking meters, and vending machines, to energy and water management, landscaping/ irrigation, and digital signage.



## Smart City

Sensors, surveillance cameras, street and outdoor lighting, utility meters and various other smart devices connected to the Internet accumulate data, which is processed in data analyzing centers, and is further used to optimize the communication between citizens and utilities, leading to a smooth functioning of an efficient city.

## Smart Grid

The success of a Smart Grid lies in setting up efficient and reliable networks consisting of computers, sensors, and automation technologies. These are more secure, greener, and enable seamless integration of renewable technologies like wind and solar power.



## Industry 4.0

Amphenol, as a leader in technological advancements, is equipped with a range of connector and cable solutions to support various equipment-enabling Industry 4.0 applications. These interconnect components are tough, durable, and feature the most advanced sealing, ingress protections, and electromagnetic shielding demanded by the harsh factory environments.

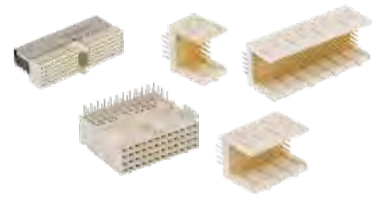

### Industrial Backplane Connectors

- 2.00 mm Millipacs® series hard metric connector, 2mm Metral® series future bus connector & 2.54mm DIN 41612 connector for robust applications in the Industrial segment
- Features 2-beam twisted tulip contact which provides an equalized signal path



### High Temperature Backplane Connectors

- Feature-packed connectors designed for use in higher operating temperature applications. Compliant to EN45545



### ComboStak® 0.80mm / 2.00mm

- Hybrid and medium power solution
- 0.8A signal, 20A power
- Signal speed up to 12Gb/s.

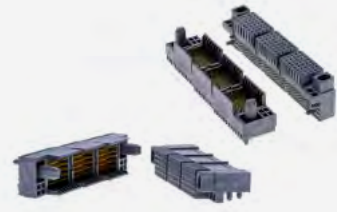

### Millipacs® Plus

- Configurable meeting designers' choice of signal data rates from 3Gbps to 25Gbps and power up to 40A and with multiple guiding options
- Compliant to Hardmetric equipment practice and complimentary to 2mm Millipacs standard
- Options for Hotswapping, EMI shielding and high temperature

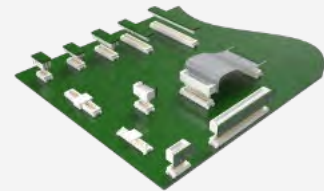

### Conan® 1.00mm

- Secure, reliable connector
- Audible "click" to ensure perfect mating
- Speed up to 8 Gb/s.

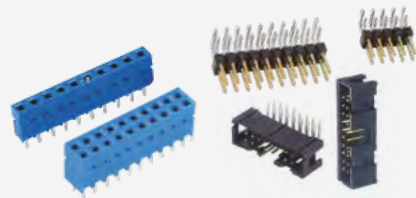

### Modular Systems 2.54mm/ 2.00mm

- Dubox®, Quickie®, BergStik®, PV® 2.54mm, Minitex® 2.00mm
- Industry proven connector system
- Board to Board, Wire/Cable to Board



### Minitex® Pwr Connector and Cable Assemblies

- Complete interconnect solutions for wire-to-wire and wire-to-board
- Available in pitch sizes of 3.00mm, 4.20mm and 5.70mm
- Current ratings from 5A to 28A

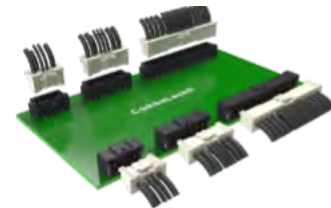

### ComboLock® 1.00mm/3.00mm

- Compact, hybrid wire-to-board connector.
- Active Positive Latching
- 1.5A signal, 10A power

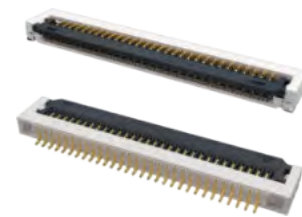

### FFC/FPC Connectors

- From 0.21mm to 2.0mm pitch with various heights ranging from 0.5mm to 6.25mm.
- Easy to operate and high vibration-proof performance
- Automotive grade versions compliant with USCAR2 and LV214 are available
- FFC cable can be supported as a whole solution



### D-Sub Slimline

- Ultra slim body with contact
- alignment in a single row for significant saving in board space and with mating compatibility



### ix Industrial Ethernet

- Next gen ruggedized interface
- IEC 61076-3-124, Cat6A, PoE++
- IP20 & IP67 connectors & cables
- ix-Mag with integrated magnetics
- Factories, Robotics applications



### OCTIS™ Outdoor IO

- Robust I/O for high reliability and performance



### Lighting Connectors

- Lighting connectors & cables
- NEMA/ANSI C136.41
- Zhaga Book 18 and Book 20
- LED indoor, outdoor, street lighting applications



### Single Pair Ethernet

- Next gen ruggedized interface
- IEC 63171-6, PoDL
- IP20 & IP67 connectors & cables
- Industrial Ethernet to the sensor and actuator level



### Ruggedized

- Ruggedized, IP67 sealed
- Connectors & cables
- RJ, USB, USB-C, D-Sub, HDMI
- MRD Circular latching
- FLH rectangular latching
- Industrial, commercial, lighting

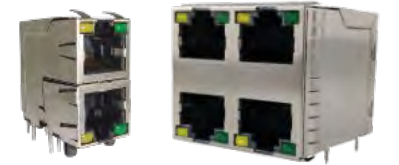

### RJ / Modular Jacks

- Cat5, Cat5e, Cat6, Cat6A
- Single port, ganged, stacked multi-port, LEDs, shielded
- Vertical, right angle
- PoE++ capability
- Industrial, commercial, medical, consumer, military applications

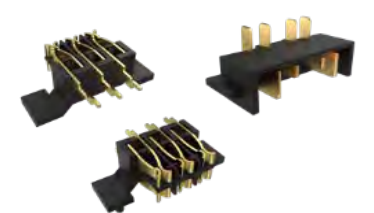

### Custom Battery Pack Connectors

- Robust battery pack charger connectors and terminal solutions for cordless power tools, lawnmowers, cordless vacuum cleaners, and personal care devices
- Available in various pin configurations and connector sizes with current ratings up to 45A.
- IP67 rated in both mated and unmated condition



### DisplayPort 2.1 Connectors

- DP2.1, UHBR20, 80Gbps/4 Lanes, 85ohm, for DP80 cable
- Backward compatible to DP1.4 footprint.
- Optional for flange and plastic post.



### PCIe® M.2 Gen 5 and Gen 4

- 67 contacts on 0.50mm pitch fully compliant with PCI-SIG PCIe® M.2 specification
- Dual Stacked, Shielded versions are available
- Right angle, vertical and various connector heights and keying options offered

## IoT High Speed

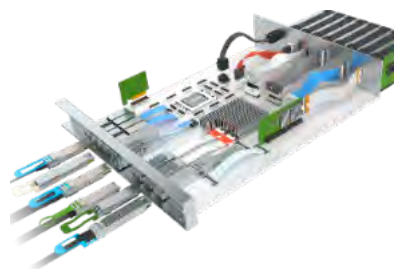

### OverPass™ Cable System

INDUSTRY-LEADING DIRECT HIGH-SPEED INTERCONNECT  
Amphenol's OverPass™ cable system offers a broad range of capabilities that allow our customers to efficiently transmit high speed signals from near an ASIC to anywhere in their system.



### SD/Micro SD Express Series Connectors

- PCIe Gen3\*1/ Gen4\*1 lane
- Backward compatible to UHS-I/UHS-II in one socket (3-in-1 solution)
- Push push/push pull structure



### Slim Cool Edge for High-Speed Hybrid Design

- 0.65mm pitch one-piece support high speed, sideband and power hybrid solution
- Supports high speed up to 32GT/s (or 56GT/s PAM4) capability
- Supports up to 330pin maximum

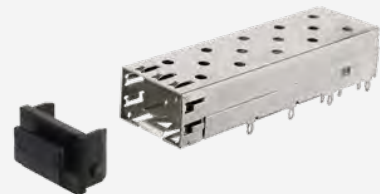

### SFP Product Family

SUPPORTS APPLICATIONS FOR UP TO 6 Gbps PER CHANNEL.  
The connector accepts multiple transceivers per INF-8074i and combines, transmits, and receives functions in a low cost, compact format.



### USB Type-C Connectors

- Performs to USB4 and Thunderbolt4 high-speed specifications, and backward compatible with USB3.2 Gen1 and Gen2
- Waterproof versions featuring unique O-ring technology (LIM) perform up to IPX8
- Supports up to 240W (5A/48V) power supply



### PCIe® Gen4 and Gen5

- X1, X4, X8, X16, X24, X32 standard links
- 1.00mm pitch, vertical and right angle with options for ridge, locked latch, side latch, blade hold down, open wall
- Extensive range include options for surface mount, through-hole solder, press-fit and straddle mount terminations and keying options offered



### ExpressPort® SFP+

Minimizes impedance discontinuities and reflections at high data rates and provides a 10 to 20 dB improvement in Near-End Crosstalk

## IoT High Speed



### Lynx™

HIGH SPEED AND DOUBLE DENSITY LOW-PROFILE BOARD-TO-BOARD CONNECTOR  
Amphenol's Lynx™ is a 4-row product offering doubling the density in a 2-row footprint that is suitable for a wide variety of applications in datacom, enterprise server, industrial, medical and more.



### QSFP28 100G Transceivers

LOW POWER CONSUMPTION, DUAL RATE SUPPORT, HIGH SPEED AND HIGH RELIABILITY  
Amphenol 100G QSFP28 transceivers include SR4,CWDM4, LR4 and ER4 lite, adopt MPO or LC interface and compatible with IEEE802.3bm, SFF-8636 and other standards.



### ExtremePort™ OSFP 112G Connectors

112GB/S PAM-4 WITH UP TO 800GB/S AGGREGATED BANDWIDTH  
Amphenol's ExtremePort™ OSFP 112G interconnect system is comprised of a 60 position, 0.60mm pitch connector designed for high-speed serial applications.



### Lynx™ QD

THE QUAD DIFFERENTIAL SOLUTION  
Optimized for differential pair signaling, Lynx™ QD sets a new standard for density and flexibility that offers an innovative, high performance interconnect with PCIe® Gen 5 support. Lynx™ QD supports data rates of 56 Gb/s PAM4.



### SFP+ 10G Transceivers

LOW POWER CONSUMPTION, HIGH SPEED, HIGH RELIABILITY  
Amphenol's SFP+ 10G optical transceivers include SR, LR, ER, ZR and support duplex, bidi, cwdm, and dwdm solutions. They adopt a LC interface and are compatible with IEEE802.3ae, SFF-8472, SFF-8431 and other standards.



### DensiLink® OverPass™ Assemblies

112G DOUBLE ENDED HIGH PERFORMANCE CABLING INTERCONNECT  
DensiLink® OverPass™ products remove high speed signaling from the PCB and create a double ended, high performance



### SFP28 25G Transceivers

LOW POWER CONSUMPTION, HIGH SPEED, HIGH RELIABILITY  
Amphenol 25G SFP28 optical transceiver includes SR, LR Lite, LR, ER, etc, adopt LC interface and compatible with IEEE802.3by. Mainly applied in 25G Ethernet, CPRI10 and other environments.

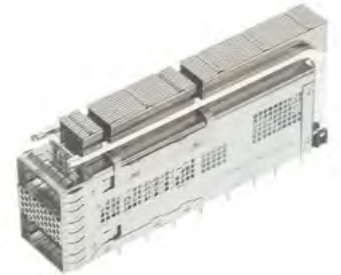

### ExtremePort™ QSFP DD 112G Connectors

COMPRISED OF A 76 POSITION 0.8mm PITCH CONNECTOR  
Designed and built for use in high-speed serial applications. Each port supports up to 800Gb/s in aggregate over an 8 x 112Gb/s electrical interface. The cage and connector design provides backwards compatibility to QSFP56 modules.

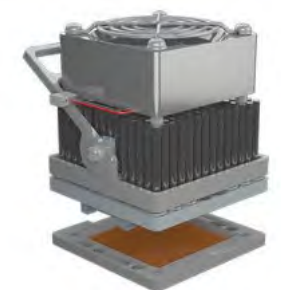

### SK Series - Sockets

HIGH PERFORMANCE COMPRESSION MOUNT SOCKETS  
Amphenol's patented compression mount contact technology utilizes industry-leading alloys to make cost effective and electrically robust socket solutions that offer high performance. With designs supporting pitches down to 0.4mm and speeds up to 40GHz.

## APPLICATION SCOPE

# Industry 4.0

Amphenol as a leader in technological advancements, is equipped with a range of connector and cable solutions to support various equipment enabling Industry 4.0.



### Programmable Logic Controller

Amphenol provides innovative interconnect solutions that meet the challenges of implementing communication standards like Profinet, DeviceNet, and Modbus into PLC systems for efficient sensor and device control.



### Uninterruptible Power Supply (UPS)

From high power drawer and busbar connectors to smart communication interfaces like RJ45 and USBs, Amphenol provides interconnect solutions that add to the reliability of UPS.



### Robotic Arm

Amphenol offers a range of rugged, high current connectors with EMI shielding as well as high data rate industrial Ethernet connectors which ensures a safe and reliable operation of the Robotic Arm.



### Servo Drive & Control Cabinet

Amphenol's advanced power connectors and data interconnect solutions establish enhanced connectivity and flawless communication in these systems.



### Human Machine Interface & Computerized Numerical Control

Amphenol provides reliable connector solutions in these devices, ranging from memory and media connectors to data interconnects and FPC board connectors.



### Robot-Control

Amphenol offers a varied range of high-performance and cost-effective PCB and I/O signal and power solutions that maximizes the efficiency of robotic controls.



### Industrial Ethernet Switch

Amphenol offers robust connector solutions that support industry grade dependability, network redundancy and includes support for Power over Ethernet (PoE) and Power over Data Line (PoDL) that enhance the connectivity of the switches.



### Power Supplies

Amphenol offers high power, high current connectors that enhance the performance and durability of various power supply units from electronic devices that convert AC to DC, to benchtop equipment used for precision testing.



### Test and Measurement

From advanced USB connectors to high-power interconnects, industrial Ethernet, and PCIe connectors, Amphenol offers high performing interconnect solutions for benchtop testing devices, handheld test equipment and test and measurement modules.



### Industrial PC

Amphenol provides advanced and rugged industrial I/O and PCB connectors that go inside industrial PC compliant with IEC-61850-3 and IEEE 1613 standards.



### Industrial Embedded Computing

Amphenol offers advanced, industrial I/O and PCB solutions that are built into Industrial Embedded Computers typically designed to work in harsh environments, are rugged enough to withstand wide temperature ranges and meet standards like IEC 68-2-27



### Single board computing

Amphenol provides various connector solutions to augment the value of your SBC designs.

## Industry 4.0



### Single Pair Ethernet (SPE) IP67 Circular Push-Pull Connectors and Cables

NEXT GENERATION IEC63171-6 (M12 PUSH-PULL FORM FACTOR) COMPLIANT SEALED INDUSTRIAL ETHERNET CONNECTORS SPE connectors for Industrial applications bring direct Ethernet connectivity to peripheral devices like sensors, actuators, and vision system cameras that operate at speeds up to 1Gb/s.



### D-Sub High Performance Board-Mount Connectors

PERIPHERAL I/O CONNECTORS WITH MACHINED CONTACTS UP TO 50 POSITIONS  
Amphenol's FCI D-Sub High Performance Board-Mount Connectors are designed for severe environment applications industrial of telecommunications, aerospace, military (125°C) class and for particularly severe applications, especially high temperature (+155°C) class.



### BergStak Secure Connector

HIGH SECURITY/HIGH DENSITY / HIGH SPEED BOARD TO BOARD CONNECTOR One-time option with tamper free screw; terminals and shielding for high security needs. EMI shielding supports 10A power transmission, open pin field design for 32Gb/s.



### ix Industrial™ IP6X Rectangular Push-Pull Connectors and Cables, NDH Series

SEALED IX INDUSTRIAL™ LATCHING INTERFACE FOR RUGGED APPLICATIONS The ix Industrial™ IP6X Rectangular Push-Pull connector and cable solution provides Cat6A Ethernet connectivity using the IEC 61076-3-124 mating interface.



### Minitek® MicroSpeed 1.00mm Board-to-Board Connector

EMI SHIELDED HIGH-SPEED BOARD TO BOARD CONNECTOR SYSTEM Shielded connector family with superior EMC performance, Poka-yoke polarization supports blind mating and the dual beam contact system offers up to 25Gb/s.

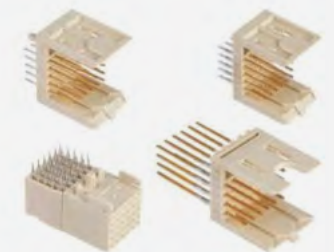

### Metral Backplane

Amphenol's FCI Metral® product family are designed in accordance with IEC 61076-4-104 and Telcordia GR-1217- CORE. One of the most popular connector series Metral® offers the broadest range of backplane connector solutions which includes right angle and vertical for both header and receptacle series.



### Rugged MRD Series Circular Locking Connectors

IP67 HARSH INDUSTRIAL CONNECTORS MRD series connectors are available in 2, 3, 4, 5, 6, 7, 8 and 9 position form factors. Housing options include all plastic constructions as well as metal locking bodies for greater durability.



### ComboStak® Board-to-Board Connectors

COMPACT, HYBRID BOARD TO BOARD CONNECTORS Signal and power in 1 connector saves space and avoids tolerance and alignment problems. Self alignment housing supports blind mating.



### Millipacs Backplane Connectors

Amphenol's FCI Millipacs® is a 2.00 mm grid Interconnection system in hard metric configuration designed in accordance to IEC 917, IEC 61076-4-101, Telcordia GR-1217-CORE standards and fulfills Compact PCI bus architecture.



### DIN 41612 High-Temperature Headers and Receptacles

HARSH ENVIRONMENT CONNECTOR ENHANCED FOR INDUSTRIAL APPLICATIONS DIN 41612 High Temperature (HT) connectors meet the fire safety standards required in Industrial (Transportation, Power) market.



### Minitek® 2.00mm - Board to Board

INDUSTRY PROVEN MODULAR CONNECTOR SYSTEM Complete, modular connector system built around a reliable dual beam contact system. Offers all PCB interconnection types and saves up to 38% PCB space compared to 2.54mm systems.



### PCI Express® Gen 4 and Gen 5 Card Edge Connectors

EXTEND DIFFERENTIAL SIGNALING TO 16GT/S AND 32GT/S FOR NEXT-GENERATION SYSTEMS Amphenol's expansive range of vertical and right-angle 1.00mm pitch PCIe® Gen 4 and Gen 5 connectors enable all generations of PCI Express® signaling and supports backward mating, and are footprint compatible with PCIe 3/2/1.



### Modular Jack - Rugged

RUGGED RJ PANEL MOUNT CONNECTOR IP67 SEALING Ruggedized RJ connectors with die cast housings and IP67 sealing for Harsh Environment applications, providing reliable performance in extreme conditions for the most demanding applications, and mate with standard RJ plugs.



### 0.50mm Power Pin Floating Board-to-Board Connectors

HIGH SPEED HIGH CURRENT POWER PIN BOARD-TO-BOARD CONNECTORS Power pin 0.50mm pitch floating board-to-board connector system is designed for applications with large current and require space saving features, supports high-speed data rate up to PCIe® Gen4 16Gb/s.



### CoolPower® SDM Connectors

HIGH CURRENT COOLBAND POWER CONTACTS FOR MAXIMUM PERFORMANCE CoolPower® Slim Drawer Mini (SDM) Connectors offer a high level of mating configuration flexibility, current density, and a thin profile making it ideal for compact board-to-board power interconnects.



### DDR5 SO-DIMM Connectors

HIGH SPEED HIGH DENSITY SO-DIMM SOCKETS DDR5 SO-DIMM connectors deliver high-speed and bandwidth. Being half the size of regular DIMMs, they lower power consumption and promote better thermal management.



### Rugged USB Type C

RUGGED USB TYPE C CONNECTOR FOR HARSH ENVIRONMENT APPLICATION, GENERATION 2 Amphenol's MUSBR series USB Type C Connectors serve many markets and applications across the globe including Automotive, Communications, Consumer, Data, Industrial and Medical.



### Minitek® Pwr Family Connector System

COMPACT, ROBUST AND VERSATILE A complete solution including wire-to-wire and wire-to-board, in pitch sizes ranging from 3mm to 5.7mm with current ratings from 5A to 23A per contact.



### BarKlip® BK300 Connector

LOW RESISTANCE-HIGH POWER BUSBAR CONNECTOR The BarKlip® BK300 connector features 14 independent conducting beams that maintain contact with the mating busbar.



### PCIe® M.2 Gen 5 Card Edge Connectors

HIGH DENSITY HIGH PERFORMANCE CONNECTOR Amphenol's PCIe® M.2 Gen 5 Connectors provide 67 contacts on 0.50mm pitch. It occupies less board space, offers more connector height options and supports higher data rates compared to PCIe® Mini Card connector.



### Magnetic Jack (RJMG) - 2xN

STACKED AND GANGED RJ45 SOLUTION SUPPORTING 100BASE-T, 1, 2.5, 5 AND 10GB/S Ethernet PHY RJMG series offers a wide variety of fully RoHS compliant Magnetic Modular Jacks for RJ45. The right angle and through hole type is offered in 2xN (2x1, 2x2, 2x4, 2x6, and 2x8) port with tab-up and tab-down options.

Industry 4.0  
**High Speed**



**Chameleon®**

ADAPT AND ADVANCE TO THE NEXT GENERATION  
 With performance speeds up to 25 Gbps+, Chameleon meets the demand for faster, smaller and more compact connector solutions. Chameleon delivers a new level of performance unlike any other platform connector on the market today.

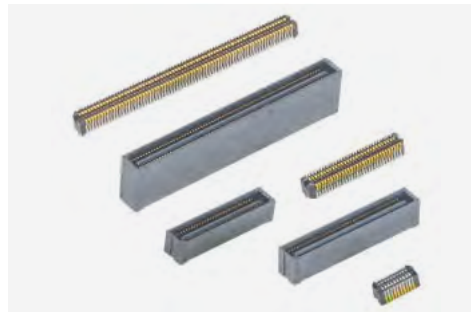

**Lynx™**

HIGH SPEED AND DOUBLE DENSITY LOW-PROFILE BOARD-TO-BOARD CONNECTOR  
 Amphenol's Lynx™ is a 4-row product offering doubling the density in a 2-row footprint that is suitable for a wide variety of applications in datacom, enterprise server, industrial, medical and more.



**Lynx™ QD**

THE QUAD DIFFERENTIAL SOLUTION  
 Optimized for differential pair signaling, Lynx™ QD sets a new standard for density and flexibility that offers an innovative, high performance interconnect with PCIe® Gen 5 support. Lynx™ QD supports data rates of 56 Gb/s PAM4.



**SK Series - Sockets**

HIGH PERFORMANCE COMPRESSION MOUNT SOCKETS  
 Amphenol's patented compression mount contact technology utilizes industry leading alloys to make cost effective and electrically robust socket solutions that offer high performance. With designs supporting pitches down to 0.4mm and speeds up to 40GHz.

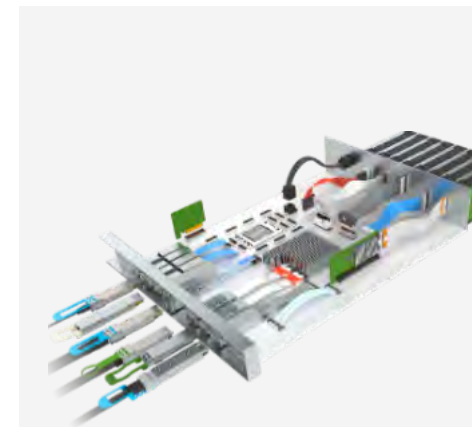

**OverPass™ Cable System**

INDUSTRY-LEADING DIRECT HIGH-SPEED INTERCONNECT  
 Amphenol's OverPass™ cable system offers a broad range of capabilities that allow our customers to efficiently transmit high speed signals from near an ASIC to anywhere in their system.



**VHDM, VHDM-HSD**

SCALABLE DESIGN SUPPORTING UP TO 25 Gb/s  
 Scale systems to next generation speeds without costly re-designs. Single ended and differential design; supports embedded capacitors. 5, 6, and 8 row available.



**cStack™**

CUSTOMIZABLE SOLDERLESS INTERPOSER-BASED ONE-PIECE STACKER  
 The Amphenol cStack™ high speed solderless interconnect solution provides limitless flexibility for board-to-board mezzanine applications and board-to-board stackable and coplanar applications when terminated to a flex circuit.



**InfinX Mezzanine Connectors**

OPTIMIZED FOR PERFORMANCE AND DIFFERENTIAL PAIR SIGNALING  
 The InfinX® high-speed mezzanine connector solution is designed to meet the needs of 25+Gb/s applications. Available in 4- and 6-Pair configurations, InfinX is your best choice for high speed board-to-board applications.



**Leap® On-Board Transceiver**

SMALL, FAST AND POWER EFFICIENT.  
 Amphenol's 300Gb/s Leap® High-Speed Optical Module is faster, smaller, and more cost and power efficient than most conventional datacenter interconnects.



**ExtremePort™ QSFP DD 112G Connectors**

ENABLES 400G and 800G AGGREGATE INPUT PER PORT  
 A 76-position, 0.8mm pitch connector built for use in high-speed serial applications. One of the industry's leading multi-lane pluggable form factors used across Ethernet, Fibre Channel and InfiniBand.



**ExtremePort™ OSFP 112G Connectors**

112GB/S PAM-4 WITH UP TO 800GB/S AGGREGATED BANDWIDTH  
 Amphenol's ExtremePort™ OSFP 112G interconnect system is comprised of a 60 position, 0.60mm pitch connector designed for high-speed serial applications.



**DensiLink® OverPass™ Assemblies**

112G DOUBLE ENDED HIGH PERFORMANCE CABLING INTERCONNECT  
 DensiLink® OverPass™ products remove high speed signaling from the PCB and create a double ended, high performance cabling interconnect. These cables support 56G and 112G signaling in hardware system designs.





# APPLICATION SCOPE

# Lighting

Amphenol is a leader in the Commercial and Industrial markets with an expanding range of lighting interconnect products.



## Street Lighting

As a member of the Zhaga Consortium, Amphenol offers standardized lighting connectors for photocells with dimming and sensor capabilities to equip remote-controlled IoT based street lighting.



## Interior Lighting

Amphenol offers LED lighting solutions for interiors that are compliant to Zhaga standards.



## Outdoor Lighting

Amphenol offers outdoor Ethernet solutions that are Power over Ethernet (PoE) capable with Cat5E performance, as well as IP67 outdoor locking connectors for harsh environments.



## Controllers

Modern automobiles are rich with ADAS features like smart LED lighting for adaptive headlights, and superior interior lighting. Amphenol provides a range of advanced USCAR2 compliant connectors like Minitek Microspace™, which are compact and meet LV214 standards.

## Lighting



### ANSI C136.41 FLA Series Receptacles & Caps

FLA Series C136.41 receptacles are available in 3, 5 and 7 position fixed and rotatable variants, providing power and dimming/control signal connections between the luminaire and a mated photocell in commercial street and utility lighting applications. Caps are available for use when a photocell is not mounted to the receptacle.



### Zhaga Book 18 FLS Series Products

Zhaga Book 18 specifies the street light mounted luminaire receptacles, and the mating bases and domes used for the corresponding photocells and sensor modules needed for Smart City applications. The 4 contacts provide DALI protocol signal, Power and digital I/O connections between the receptacle and the mated sensor.



### Zhaga Book 20 FLM Series DALI connectors

Zhaga Book 20 specifies the 2 position DALI-2 (Digital Addressable Lighting Interface) connector interface between interior LED lighting control modules and easily replaceable, interchangeable sensors used for presence detection, temperature and air quality sensing and other applications.



### FLH Series Mini Sealed 2.50mm Pitch Connectors

FLH IP67 sealed, latching wire-to-wire and wire-to-board connectors are available in 3 and 6 position housings providing 2, 3, 4, and 6 contact options and up to 7A of current handling with 18AWG wire. Ideal for lighting and other applications in Harsh environments requiring a waterproof interface.



### ANSI C136.41 FLB Series Bases & Domes

FBA Series C136.41 bases and domes form the foundational interconnect platform for manufacturers of photocells, sensors and communication modules used in commercial street lighting and utility applications.



### FLK Series Knife Switch

KNIFE SWITCH PROVIDES A SAFETY DISCONNECT FOR STREET LIGHT LUMINAIRES  
Knife Switch connectors are designed to automatically disconnect the internal wiring from the main supply inside the street lighting fixture when it is opened for servicing. This will help the technicians to safely repair, clean and maintain luminaire. Knife switches consist mating Plugs and Receptacles and are available in 3 position, single wire entry style.



### FLT Series SMD Terminal Block

FLT TERMINAL BLOCKS PROVIDE DISCRETE WIRE CONNECTION TO A PCB  
Amphenol's FLT Terminal Block is a surface mount device for discrete wire connection to a PCB for LED Modules and other applications. They provide easy, secure push-in connections compatible with a range of wire gauges.



### Rugged MRD Series Circular Locking Connectors

MRD Series IP67 latching cable-to-cable and cable-to-panel circular connectors are available in 2 shell sizes with 2 to 9 positions, providing a tough mating interface for the harshest applications. All plastic, or plastic and metal housings feature metal thumb release latching for positive mating with an audible click for latching assurance.



### Griplet® Miniature IDC Connector

RELIABLE CONNECTION AND EASE OF INSTALLATION FOR WIRE-TO-BOARD TERMINATIONS  
Amphenol's FCI Basics Griplet® Miniature IDC Connector offers a robust solution for miniature IDC wire-to-board connections. Its low profile and compact design makes Griplet® an ideal connector where space is tight and ease of installation is important.



### 0.50mm FFC/FPC Connectors with Autolock Mechanism - F308/F332 Series

RIGHT ANGLE NON-ZIF FLEX AUTOLOCK CONNECTORS  
F308/F332 series is a 0.50mm pitch right angle Non-ZIF flex connector with an auto-lock mechanism and surface mount termination. It features a height of 2.45mm and comes in 6 to 68 contacts.

## Lighting High Speed

### Chameleon®

ADAPT AND ADVANCE TO THE NEXT GENERATION  
With performance speeds up to 25 Gbps+, Chameleon meets the demand for faster, smaller and more compact connector solutions. Chameleon delivers a new level of performance unlike any other platform connector on the market today.



### Minitek MicroSpaceXS™ 1.27mm Crimp-to-Wire Connector Platform

COMPACT, ROBUST AND VERSATILE CONNECTOR SYSTEM  
Minitek MicroSpaceXS™ Crimp-to-Wire connector platform's unique design meets LV214 Severity-3 and USCAR-T2V2 specifications.



### Minitek MicroSpaceXS™ Waterproof 1.27mm Crimp-to-Wire Connector Platform

COMPACT, ROBUST AND VERSATILE CONNECTOR SYSTEM  
Minitek MicroSpaceXS™ Waterproof Crimp-to-Wire connector platform's unique design is compatible to LV214 Severity-3 and USCAR-T2V2 specifications.



### Lynx™

HIGH SPEED AND DOUBLE DENSITY LOW-PROFILE BOARD-TO-BOARD CONNECTOR  
Amphenol's Lynx™ is a 4-row product offering doubling the density in a 2-row footprint that is suitable for a wide variety of applications in datacom, enterprise server, industrial, medical and more.



### Lynx™ QD

THE QUAD DIFFERENTIAL SOLUTION  
Optimized for differential pair signaling, Lynx™ QD sets a new standard for density and flexibility that offers an innovative, high performance interconnect with PCIe® Gen 5 support. Lynx™ QD supports data rates of 56 Gb/s PAM4.

## APPLICATION SCOPE

# Server & Storage

Amphenol is a leader in providing industry proven solutions used across server and storage equipment, and next-generation enterprise applications.

## Applications

Amphenol provides high-density, high-performance interconnect solutions for server and storage equipment used in multiple applications and markets.

AI Servers

Server Storage

Networking /  
Telecommunications

Automotive

Consumer

Industry 4.0

## Enterprise storage

Amphenol offers a wide range of high-performance enterprise SSD connector solutions for M.2, EDSFF, SAS, U.2, U.3, SATA and PCIe applications.

Mini Cool Edge

SATA

M.2

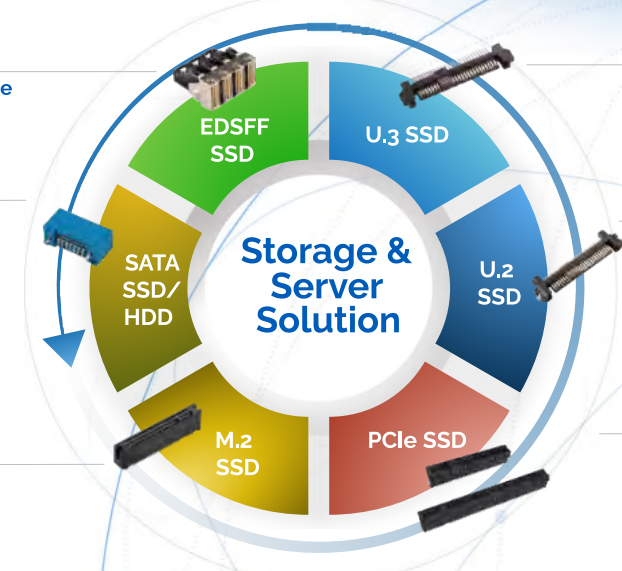

SAS/PCle  
(SFF8639)

SAS/PCle  
(SFF8639)

PCIe Gen  
4 and 5



### Mini Cool Edge for GENZ/EDSFF/OCP

- 0.60mm pitch connector, supports high speed up to 112G PAM4
- Designed to meet SFF TA1002, Gen Z, EDSFF, OCP NIC 3.0 specifications
- Vertical, right angle, straddle mount and orthogonal options are available

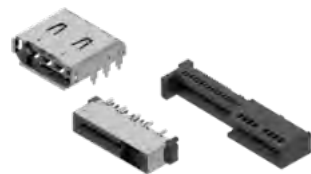

### Standard Cool Edge 0.8mm for Automotive and 5G Antenna

- Robust design with EMI shielding for Automotive Ethernet and Power applications
- Hybrid option for small cell active antenna BTB application
- One-piece small form factor to save space



### DDR5 SO-DIMM Connectors

- 262 positions connector in high-density design of 0.50mm pitch
- 4.00mm, 8.00mm, 5.20mm and 9.20mm height
- Right angle and vertical orientation with SMT mechanical hold-downs



### Double Density Cool Edge for Ultra Compact Design

- 0.80mm pitch, power and signal hybrid connector
- Highly configurable wafer design for differential, single-ended and power options
- Supports high speed of up to 32GT/s (or 56GT/s PAM4) capability



### PCIe® M.2 Gen 5 and Gen 4

- 67 contacts on 0.50mm pitch fully compliant with PCI-SIG PCIe® M.2 specification
- Dual Stacked, Shielded versions are available
- Right angle, vertical and various connector heights and keying options offered

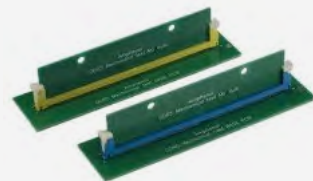

### DDR SMT Memory module Connectors

- Designed to meet JEDEC SO-016, SO-017, SO-019 and SO-023 specs
- U DIMM/R/LR Socket, Metal tab, Standard/Narrow/ latch available



### Slim Cool Edge for High-Speed Hybrid Design

- 0.65mm pitch one-piece support high speed, sideband and power hybrid solution
- Supports high speed up to 32GT/s (or 56GT/s PAM4) capability
- Supports up to 330pin maximum



### PCIe® Gen4 and Gen5

- X1, X4, X8, X16, X24, X32 standard links
- 1.00mm pitch, vertical and right angle with options for ridge, locked latch, side latch, blade hold down, open wall
- Extensive range include options for surface mount, through-hole solder, press-fit and straddle mount terminations and keying options offered



### PSAS, SAS and SATA Connectors

- SAS connectors (29-pins) support hot plugging and blind mating of HDDs/SSDs, 2 signal lanes support up to 24Gb data rate (SAS 4.0).
- PSAS connectors (68pins) support SAS HDD and NVME SSDs with 2 SAS lanes supporting up to 24G data rate and 4 PCIe lanes supporting up to 32G (PSAS 5.0) data rates.



### Compression, Board to Board Connectors and Interposer

- Provides a connection between either two PCB modules or one PCB and an electrical module
- Single-piece compression-type or two-piece board-to-board surface mount connectors



### ExtremePort™ Z-Link

- Compliant with Gen-Z and OCP NIC specifications, SFF-TA-1002/1020 solution
- High speed of up to 56Gb/s PAM4
- Supports both cable and card edge applications



### RJMG

- 10/100T, 1GBT (10/100/1000-BT), 2.5G, 5G, 10G, Power Over Ethernet (PoE, 15W~150W), integrated with surge protection.
- Commercial 0~70°C and industrial -40~85°C & -40~105°C.
- Meets IEEE802.3ab and supports various Ethernet PHY



### Mini Cool Edge IO

- Up to 64Gb/s PAM4, PCIe® Gen 4, PCIe® Gen 5, PCIe® Gen 6, over 1.0 meter transmission distance
- 0.60mm pitch connectors support both cable and card edge connections
- Options for 92Ω, 85Ω and 95Ω impedance and various pin number options - meeting PCIe®/NVMe/SAS/SFP(+)/QSFP specifications



### ExtremePort™ Swift

- Ultra-low profile, 0.60mm pitch connector in 8X, 16X configurations. Mating height 8.38mm
- Designed for unshielded, internal I/O connectors
- With 85Ω impedance and meets PCIe® Gen 5 NRZ 32G specifications



### Power Connectors

- Wire to Board connectors in 3.0 mm and 4.2mm pitch with current ratings from 6.5A to 20A per pin
- Designed for IT and Datacom applications



### Multi-Trak™

- Combines original PCIe® and Mini Cool Edge IO in one connector to provide both power (21A) and high/low-speed signal
- Up to 56Gb/s PAM4, PCIe® Gen 5, and target PCIe® Gen 6
- Options for 85Ω impedance and various pin number options - meeting PCIe®/NVMe/SAS/OCP DC-MHS/ SFF-TA-1033 specifications



### USB Type-C Connectors

- Performs to USB4 and Thunderbolt4 high-speed specifications, and backward compatible with USB3.2 Gen1 and Gen2
- Waterproof versions featuring unique O-ring technology (LIM) perform up to IPX8
- Supports up to 240W (5A/48V) power supply



### Fan Connectors

- Blind-Mate Interface Wire to Board connectors from 1.25mm to 2.54mm pitch with max current rating 5.5A/pin. Designed for Server and Storage applications
- Card to Wire connectors in 2.44mm and 2.54mm pitch with current rating 4A/pin. Designed for Switch application

## Server & Storage



### BarKlip® BK500 IO

- Distributes up to 500A per contact
- Simple configurable plug-and-play solutions
- Fully compliant with ORv3 Power Output Specifications



### BarKlip® BK150 IO

- Distributes up to 150A per contact between busbars, cables, and circuit boards
- Simple configurable plug-and-play solutions
- Fully compliant with ORv3 IT Gear Power Input Solution Specifications



### AC Input Connector and Cable Assemblies

- 7-Pin connector designed for Star, Delta, and single-phase connections
- Simple configurable plug-and-play solution designed to meet various current and voltage ratings
- Fully compliant with OCP ORv3 Power Shelf Universal Input Connect Specifications



### BarKlip® XP300/ XP200

- Current ratings up to 300A and 200A
- Mates with 3.0mm busbar
- ±2.0mm gatherability



### CoolPower® SDM

- Up to 35A per pin, high current Coolband contact technology
- Backplane, coplanar, and orthogonal configurations available
- 2 position or 4 position available



### EnergyEdge™ X-treme

- 3000W at 12V
- Available in straddle mount, right angle, right angle coplanar, and vertical configurations
- 25% increase in current linear density



### PwrBlade® MiniMezz

- Up to 50A per contact (high power) and 25A per contact (low power)
- Available stack heights range from 8mm to 20mm (tooled in 1mm increments)
- +/- 0.80mm gatherability for blind mate applications



### PwrBlade® Mini Cable-to-Board Connector

- Rated up to 25A per power contact (50A/column) without exceeding 30°C temperature rise in still air
- Modular tooling design
- 12AWG for power contacts and 26AWG-22AWG available for signal contacts



### PwrBlade® Mini Board-to-Board Connector

- Rated up to 45A per high power contact (4 adjacent contacts)
- Low profile 8.10mm height above board
- Modular tooling designs



### PwrMAX® G2

- Highest density blind-mate Power and Signal connector series
- Up to 130A per contact and 18% size reduction
- Orthogonal, mezzanine, coplanar and right-angle configurations available for both PCB and busbar applications

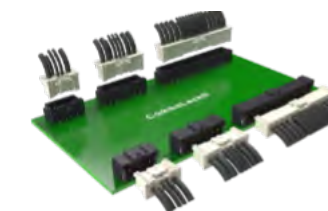

### Minitek® PICPwr OCP Connector Solutions

- Newly launched 12V connector solution supports Open Compute Project Power Distribution and Management architecture requirements
- Operating power and voltage is 864W at 12VDC

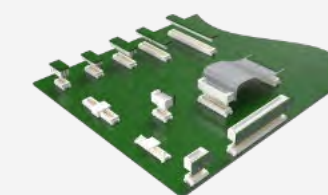

### Minitek® Pwr Connector and Cable Assemblies

- Complete interconnect solutions for wire-to-wire and wire-to-board
- Available in pitch sizes of 3.00mm, 4.20mm and 5.70mm
- Current ratings from 5A to 28A

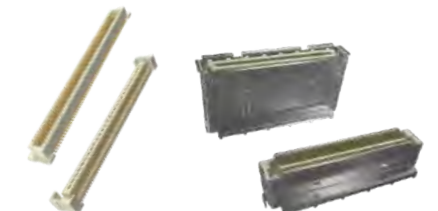

### PwrMAX® I/O Cable Connector System

- Rated up to 50A/Contact (100A/column) without exceeding 30°C temperature rise in still air
- Latching options available
- Patented GCS® and GXT® plating

### PwrBlade® ULTRA HD

- Up to 85A per contact
- 2.0mm high density signal pitch
- Ultra-low profile height of 9.6mm above board for optimized airflow

### PwrBlade® IO

- Up to 60A per contact (high power) & 25A per contact (low power)
- Power & signal contacts are highly configurable
- Wide range of wire sizes available

### ComboLock® 1.00mm/3.00mm

- Compact, hybrid wire-to-board connector.
- Active Positive Latching
- 1.5A signal, 10A power

### Conan® 1.00mm

- Secure, reliable connector
- Audible "click" to ensure perfect mating
- Speed up to 8 Gb/s.

### BergStak® 0.80mm

- Ideal for use in high density applications
- Wide range of positions and stack heights
- Speed up to 16 Gb/s.

# Server & Storage High Speed



## Lynx™ QD

THE QUAD DIFFERENTIAL SOLUTION  
Optimized for differential pair signaling, Lynx™ QD sets a new standard for density and flexibility that offers an innovative, high performance interconnect with PCIe® Gen 5 support. Lynx™ QD supports data rates of 56 Gb/s PAM4.



## InfinX Mezzanine Connectors

OPTIMIZED FOR PERFORMANCE AND DIFFERENTIAL PAIR SIGNALING  
The InfinX® high-speed mezzanine connector solution is designed to meet the needs of 25+Gb/s applications. Available in 4- and 6-Pair configurations, InfinX is your best choice for high speed board-to-board applications.



## 32G FC Transceivers

FIBRE CHANNEL LINKS UP TO 28.05 GB/S OVER MULTIMODE FIBER  
The 32G FC transceivers are designed to be used in Fibre Channel links up to 28.05 Gb/s data rate over multimode fiber. They are compliant with FC-P1-6a, SFF-8472 Rev 12.2c, and compatible with SFF-8432b.



## Chameleon®

ADAPT AND ADVANCE TO THE NEXT GENERATION  
With performance speeds up to 25 Gbps+, Chameleon meets the demand for faster, smaller and more compact connector solutions. Chameleon delivers a new level of performance unlike any other platform connector on the market today.



## Mini-SAS HD Active Optical Cable

RELIABLE HIGH PERFORMANCE INTERCONNECT SOLUTION FOR MSAS APPLICATIONS  
Amphenol's Mini-SAS HD Active Optical Cable is fully compliant to SAS 2.1 and SAS 3.0 industry standards as well as the SFF-8636 interface standard. Used primarily for external Enterprise storage applications.



## 64G FC Transceivers

SUPPORTS 57.8GB/S DATA RATE & LOW POWER  
The module is compatible with 64G FC-P1-7. Features low power - 1.5W with outstanding BER and sensitivity. Electrically hot-pluggable.



## cStack™

CUSTOMIZABLE SOLDERLESS INTERPOSER-BASED ONE-PIECE STACKER  
The Amphenol cStack™ high speed solderless interconnect solution provides limitless flexibility for board-to-board mezzanine applications and board-to-board stackable and coplanar applications when terminated to a flex circuit.



## CXP2 Active Optical Cable

HIGH DENSITY, EXCELLENT PERFORMANCE AND RELIABILITY  
Amphenol's 300G CXP2 to CXP2 Active Optical Cable is a natural choice for optical cabling in data center / high performance computing hardware applications, providing a cost effective plug and play cabling solution.



## Mini-SAS HD

LOW-PROFILE MINI-SAS HIGH DENSITY RECEPTACLE  
The next generation SAS system; the SAS 2.1 standard meets SAS-3 next generation speed and density requirements that provides faster data transmission and more bandwidth for end users.



## DensiLink® OverPass™ Assemblies

112G DOUBLE ENDED HIGH PERFORMANCE CABLING INTERCONNECT  
The Amphenol DensiLink® OverPass™ products remove high speed signaling from the PCB and create a double ended, high performance cabling interconnect. These cables support 56G and 112G signaling in hardware system designs.



## QSFP DD Copper Cable Assemblies 200G/400G/800G

NEXT-GENERATION QSFP DD CABLES  
These double-density copper cables now enable 400G and 800G in application lengths from 0.5 meter up to and including 3 meters. Cable sizes: 25 AWG - 32 AWG. Available in all 4x form factors.



## XCede® HD

SUPPORTS DESIGNS FROM 8G - 56G PAM4  
The de-facto standard for high performance backplane designs with industry leading density, Supports Embedded Capacitors.



## Mini-SAS HD Copper Cable Assemblies 6G/12G/24G

LEADING THE INDUSTRY WITH HD MINI-SAS.  
Amphenol's Mini-SAS HD product is the present generation SAS storage interface addressing multi-channel bandwidth requirements of 6Gb/s, 12Gb/s, and 24Gb/s while meeting or exceeding SAS 2.1 SAS 3 and SAS 4 specifications.



## TR Multicoax Connector

HIGHEST DENSITY HIGH SPEED COAX CONNECTOR  
TR Multicoax delivers superior signal integrity from multiple high speed analog or digital channels. With a choice of 20GHz, 40GHz, or 70GHz configurations, users can upgrade their connectors according to bandwidth requirements on their application.

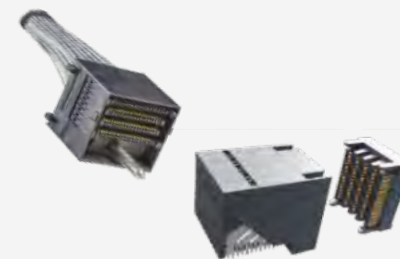

## ExaMAX®

COST OPTIMIZED WITH SCALABLE PERFORMANCE TO 112G PAM4  
Innovative design supports low insertion/ extraction forces with reduced crosstalk and low insertion loss. Flexible architecture supports direct orthogonal, traditional backplane, coplanar and cable requirements.



## QSFP28/56/112G Connectors & Cable Assemblies

SUPPORTS PER PORT DESIGNS FROM 100G, 200G AND 400G PAM4  
4 lanes per cable - 28G, 56G and 112G per lane capability. Passive & active cables; 26AWG to 32AWG cable. Stacked, ganged and belly-to-belly connector and cage configurations. Available in all 4x form factors.

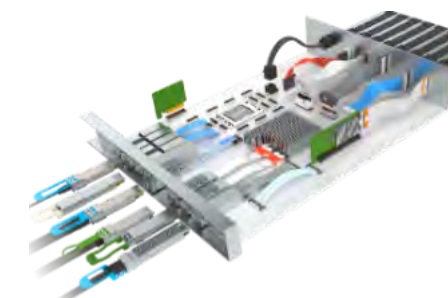

## OverPass™ Cable System

INDUSTRY-LEADING DIRECT HIGH-SPEED INTERCONNECT  
Amphenol's OverPass™ cable system offers a broad range of capabilities that allow our customers to efficiently transmit high speed signals from near an ASIC to anywhere in their system.

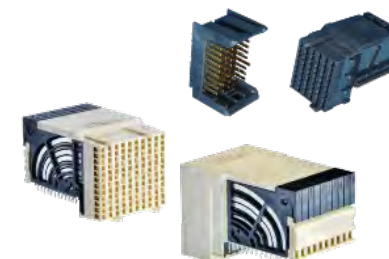

## AirMax®

COST OPTIMIZED WITH SCALABLE PERFORMANCE UP TO 56G PAM4  
Traditional backplane offering including standard and inverse gender. Standard is 3-, 4- and 5-Pair.

Server & Storage  
**High Speed**

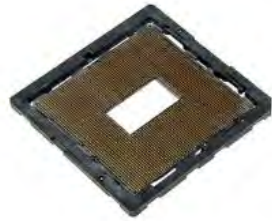

**cLGA® Land Grid Array Socket System**

HIGH PERFORMANCE, LOW COST CHIP-TO-BOARD APPLICATION  
Designed to bring conventional connector material construction to high performance, low cost chip-to-board applications. Used in applications ranging from handheld computer products to supercomputer systems.

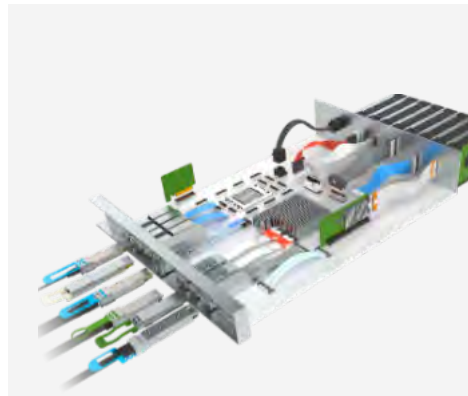

**OverPass™ Cable System**

INDUSTRY-LEADING DIRECT HIGH-SPEED INTERCONNECT  
Amphenol's OverPass™ cable system offers a broad range of capabilities that allow our customers to efficiently transmit high speed signals from near an ASIC to anywhere in their system.

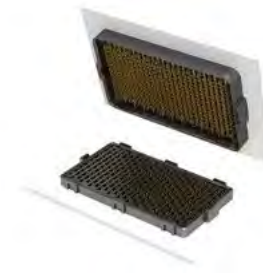

**M-Series 56 Mezzanine Connectors**

56GB/S HIGH SPEED MEZZANINE BGA CONNECTOR SYSTEM  
Leveraging proven technologies, including an industry leading BGA design, offering superior self-aligning and self-leveling. With a next generation differential pair contact design for up to 56Gb/s NRZ and 112Gb/s PAM4 performance.



## APPLICATION SCOPE

# Test & Measurement

From benchtop test equipment to mobile, handheld, and miniaturized versions with increased precision; Amphenol offers robust, high performance connector solutions that help measure these critical parameters.



### Handheld Test Devices

Today digital multimeters provide higher density testing, lower test times and higher accuracy that add to convenience and cost reduction. From handheld devices such as Voltmeters, Ohmmeters, Ammeters, and Multimeters, to test equipment for the electrical, mechanical, and environmental testing of DUTs in various fields, including medical, and commercial, Amphenol has an array of next generation interconnect solutions ideal for sleek, handheld test equipment.



### Test and Measurement Modules

With increased test speed and reduced latency, test modules are especially beneficial for data-intensive and augmented test applications. From advanced USB connectors, to industrial Ethernet and PCIe connectors, Amphenol offers high performing interconnect solutions for test and measurement modules.



### Benchtop Test Equipment

From oscilloscopes for testing consumer devices like smartphones, cameras, AV systems, PC peripherals, and related ICs, to Spectrum Analyzers used for all kinds of radio-frequency (RF) circuits to measure characteristics like the frequency response, noise and distortion - Amphenol provides high performing I/O, board-to-board and modular jacks along with industrial Ethernet solutions and high-power interconnects for various benchtop testing devices. Learn more at [amphenol-cs.com](http://amphenol-cs.com).



## Test & Measurement



### ComboStak® 0.80mm / 2.00mm

- Hybrid and medium power solution
- 0.8A signal, 20A power
- Signal speed up to 12Gb/s.

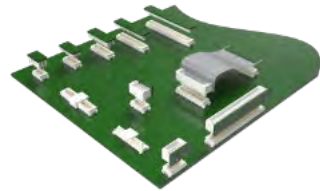

### Conan® 1.00mm

- Secure, reliable connector
- Audible "click" to ensure perfect mating
- Speed up to 8 Gb/s.

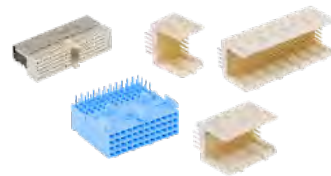

### Industrial Backplane Connectors

- 2.00 mm Millipacs® series hard metric connector, 2mm Metral® series future bus connector & 2.54mm DIN 41612 connector for robust applications in the Industrial segment
- Features 2-beam twisted tulip contact which provides an equalized signal path

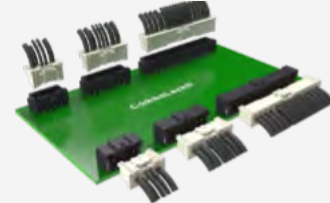

### ComboLock® 1.00mm/3.00mm

- Compact, hybrid wire-to-board connector.
- Active Positive Latching
- 1.5A signal, 10A power

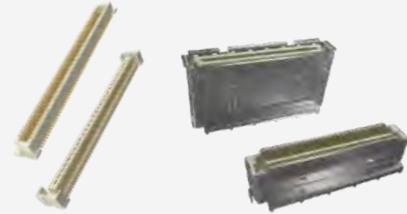

### BergStak® 0.80mm

- Ideal for use in high density applications
- Wide range of positions and stack heights
- Speed up to 16 Gb/s.



### Micro Board-to-Board

- Low profile and fine pitch for high density applications
- High current rating (Up to 5A)
- Chamfer connector design prevents mismatching

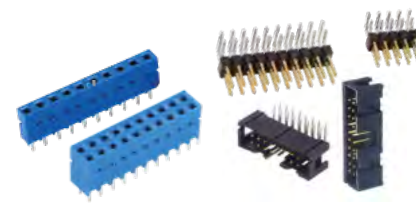

### Modular Systems 2.54mm/ 2.00mm

- Dubox®, Quickie®, BergStik®, PV® 2.54mm, Minitek® 2.00mm
- Industry proven connector system
- Board to Board, Wire/Cable to Board



### High Temperature Backplane Connectors

- Feature-packed connectors designed for use in higher operating temperature applications. Compliant to EN45545

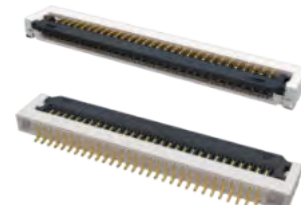

### FFC/FPC Connectors

- From 0.21mm to 2.0mm pitch with various heights ranging from 0.5mm to 6.25mm.
- Easy to operate and high vibration-proof performance
- Automotive grade versions compliant with USCAR2 and LV214 are available
- FFC cable can be supported as a whole solution



### High mating cycle connectors for Test and Measurement Equipment

- Supports 100k cycle mating/unmating – Ideal solution for test and measurement equipment.
- Non-soldering type allows replacement of connector without damaging the main PCB after 100,000 cycles
- Supports DDR5 data rate



### PCIe® M.2 Gen 5 and Gen 4

- 67 contacts on 0.50mm pitch fully compliant with PCI-SIG PCIe® M.2 specification
- Dual Stacked, Shielded versions are available
- Right angle, vertical and various connector heights and keying options offered



### USB Type-C Connectors

- Performs to USB4 and Thunderbolt4 high-speed specifications, and backward compatible with USB3.2 Gen1 and Gen2
- Waterproof versions featuring unique O-ring technology (LIM) perform up to IPX8
- Supports up to 240W (5A/48V) power supply



### DDR5 SO-DIMM Connectors

- 262 positions connector in high-density design of 0.50mm pitch
- 4.00mm, 8.00mm, 5.20mm and 9.20mm height
- Right angle and vertical orientation with SMT mechanical hold-downs



### PCIe® Gen4 and Gen5

- X1, X4, X8, X16, X24, X32 standard links
- 1.00mm pitch, vertical and right angle with options for ridge, locked latch, side latch, blade hold down, open wall
- Extensive range include options for surface mount, through-hole solder, press-fit and straddle mount terminations and keying options offered



### Ruggedized

- Ruggedized, IP67 sealed
- Connectors & cables
- RJ, USB, USB-C, D-Sub, HDMI
- MRD Circular latching
- FLH rectangular latching
- Industrial, commercial, lighting



### Compression, Board to Board Connectors and Interposer

- Provides a connection between either two PCB modules or one PCB and an electrical module
- Single-piece compression-type or two-piece board-to-board surface mount connectors



### DisplayPort 2.1 Connectors

- DP2.1, UHBR20, 80Gbps/4 Lanes, 85ohm, for DP80 cable
- Backward compatible to DP1.4 footprint.
- Optional for flange and plastic post.



### D-Sub Slimline

- Ultra slim body with contact alignment in a single row for significant saving in board space and with mating compatibility

Test & Measurement  
**High Speed**



**XCode® Backplane Connector**

ENABLING FUTURE DATA RATES. While maintaining the same mating interfaces, this connector design provides designers with readily available 85Ω and 100Ω solutions to meet a wide variety of application needs, including Ethernet and PCI.



**Chameleon®**

ADAPT AND ADVANCE TO THE NEXT GENERATION  
 With performance speeds up to 25 Gbps+, Chameleon meets the demand for faster, smaller and more compact connector solutions. Chameleon delivers a new level of performance unlike any other platform connector on the market today.

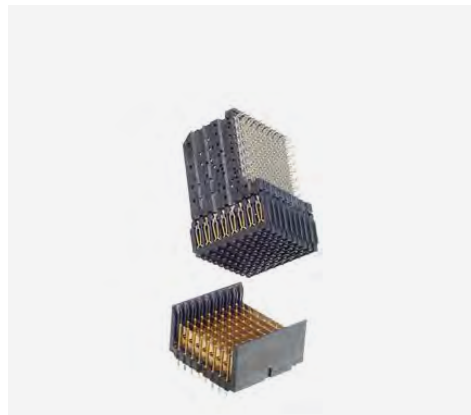

**VHDM®**

OPTIMIZED FOR SINGLE-ENDED APPLICATIONS  
 Amphenol's VHDM® connector's modular format and breadth of components provides unmatched design flexibility. VHDM's support differential signaling within the same connector.

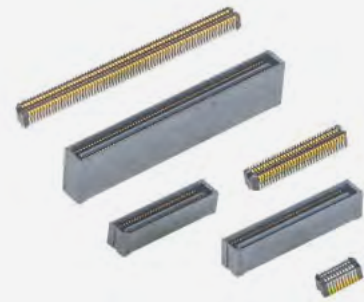

**Lynx™**

HIGH SPEED AND DOUBLE DENSITY LOW-PROFILE BOARD-TO-BOARD CONNECTOR  
 Amphenol's Lynx™ is a 4-row product offering doubling the density in a 2-row footprint that is suitable for a wide variety of applications in datacom, enterprise server, industrial, medical and more.



**ExaMAX® 56Gb/s High-Speed Backplane Connector 85Ohm**

SUPPORTS INTEL QPI/UPI AND OTHER INDUSTRY STANDARD SPECIFICATIONS  
 The ExaMAX® 85Ohms backplane connector system is designed for higher bandwidth applications from 25Gb/s to 56Gb/s. Delivers superior signal integrity performance.



**cStack™**

CUSTOMIZABLE SOLDERLESS INTERPOSER-BASED ONE-PIECE STACKER  
 The Amphenol cStack™ high speed solderless interconnect solution provides limitless flexibility for board-to-board mezzanine applications and board-to-board stackable and coplanar applications when terminated to a flex circuit.



## APPLICATION SCOPE

# Artificial Intelligence & Machine Learning

Amphenol enables connectivity solutions with density, high performance and engineering expertise



AI / MACHINE LEARNING

## Integrated Signal Integrity Solutions

Amphenol provides reliable integrated signal integrity solutions across High-Speed IO, Backplane, and Mezzanine Connectors and Cables to meet the expansive goals of AI/ML. Adhering to PCIe and DDR standards, high performance storage and memory connectors along with high-speed magnetic modular jacks and wire to board power connectors, are available for all your AI/ML applications.

## OverPass Cable System

Amphenol's OverPass™ cable system offers a broad range of capabilities that allow our customers to efficiently transmit high speed signals from near an ASIC to anywhere in their system. Reduce overall link signal loss and eliminate the need for expensive signal re-timers.



## 112G High Speed Solutions

Amphenol understands how to provide connector solutions to enable the higher speeds of today. We have the tools and expertise to help our customers get there, electrically and mechanically – and every type of connector needed for 112G integration.

Amphenol has 112Gb/s connector solutions for every application that requires a connector. Paladin® and ExaMAX® are used for mezzanine and traditional, cabled, and orthogonal backplane. Amphenol SFP, SFP DD, QSFP, QSFP DD, and OSFP connectors and cable are available for 112Gb/s applications. We also have solutions for more niche applications. For example, Mini Cool Edge and Swift support 112Gb/s channels with card edge interconnectivity.



**Double Density Cool Edge for Ultra Compact Design**

- 0.80mm pitch, power and signal hybrid connector
- Highly configurable wafer design for differential, single-ended and power options
- Supports high speed of up to 32GT/s(or 56GT/s PAM4) capability



**PCIe® Flip CEM, Slim CEM, Direct Cable Solution**

- Flip CEM with "JJ" contact or "LL" contact provides better support for card edge to save keep out area for routing as compared to standard PCIe CEM contact of "JL".
- Standard PCIe CEM footprint is 8.2mm, Slim CEM is 7.45mm, Flip CEM is 5.9mm
- Direct Cable CEM features high-speed signal pins that directly attach to cable ends to save PCB loss



**BergStak® Secure 1.00mm**

- High security, high density
- EMI Shielding
- Speed up to 32Gb/s.



**Mini Cool Edge for GENZ/EDSFF/OCP**

- 0.60mm pitch connector, supports high speed up to 112G PAM4
- Designed to meet SFF TA1002, Gen Z, EDSFF, OCP NIC 3.0 specifications
- Vertical, right angle, straddle mount and orthogonal options are available



**DDR SMT Memory module Connectors**

- Designed to meet JEDEC SO-016, SO-017, SO-019 and SO-023 specs
- U DIMM/R/LR Socket, Metal tab, Standard/Narrow/ latch available

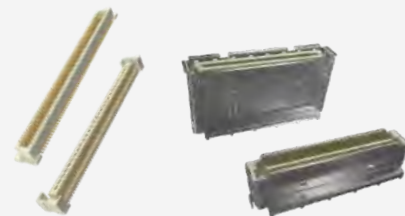

**BergStak® 0.80mm**

- Ideal for use in high density applications
- Wide range of positions and stack heights
- Speed up to 16 Gb/s.



**PCIe® Gen4 and Gen5**

- X1, X4, X8, X16, X24, X32 standard links
- 1.00mm pitch, vertical and right angle with options for ridge, locked latch, side latch, blade hold down, open wall
- Extensive range include options for surface mount, through-hole solder, press-fit and straddle mount terminations and keying options offered



**PSAS, SAS and SATA Connectors**

- SAS connectors (29-pins) support hot plugging and blind mating of HDDs/SSDs, 2 signal lanes support up to 24Gb data rate (SAS 4.0).
- PSAS connectors (68pins) support SAS HDD and NVME SSDs with 2 SAS lanes supporting up to 24G data rate and 4 PCIe lanes supporting up to 32G (PSAS 5.0) data rates.

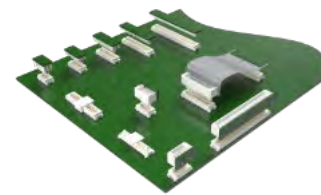

**Conan® 1.00mm**

- Secure, reliable connector
- Audible "click" to ensure perfect mating
- Speed up to 8 Gb/s.



**Mini Cool Edge IO**

- Up to 64Gb/s PAM4, PCIe® Gen 4, PCIe® Gen 5, PCIe® Gen 6, over 1.0 meter transmission distance
- 0.60mm pitch connectors support both cable and card edge connections
- Options for 92Ω, 85Ω and 95Ω impedance and various pin number options - meeting PCIe®/NVMe/SAS/SFP+/QSFP specifications



**ExtremePort™ Z-Link**

- Compliant with Gen-Z and OCP NIC specifications, SFF-TA-1002/1020 solution
- High speed of up to 56Gb/s PAM4
- Supports both cable and card edge applications



**RJMG**

- 10/100T, 1GBT (10/100/1000-BT), 2.5G, 5G, 10G, Power Over Ethernet (PoE, 15W-150W), integrated with surge protection.
- Commercial 0-70°C and industrial -40-85°C & -40-105°C.
- Meets IEEE802.3ab and supports various Ethernet PHY



**Multi-Trak™**

- Combines original PCIe® and Mini Cool Edge IO in one connector to provide both power (21A) and high/low-speed signal
- Up to 56Gb/s PAM4, PCIe® Gen 5, and target PCIe® Gen 6
- Options for 85Ω impedance and various pin number options - meeting PCIe®/NVMe/SAS/OCP DC-MHS/ SFF-TA-1033 specifications



**Fan Connectors**

- Blind-Mate Interface Wire to Board connectors from 1.25mm to 2.54mm pitch with max current rating 5.5A/pin. Designed for Server and Storage applications
- Card to Wire connectors in 2.44mm and 2.54mm pitch with current rating 4A/pin. Designed for Switch application



**Minitek® PICPwr OCP Connector Solutions**

- Newly launched 12V connector solution supports Open Compute Project Power Distribution and Management architecture requirements
- Operating power and voltage is 864W at 12VDC



**ExtremePort™ Swift**

- Ultra-low profile, 0.60mm pitch connector in 8X, 16X configurations, Mating height 8.38mm
- Designed for unshielded, internal I/O connectors
- With 85Ω impedance and meets PCIe® Gen 5 NRZ 32G specifications



**Power Connectors**

- Wire to Board connectors in 3.0 mm and 4.2mm pitch with current ratings from 6.5A to 20A per pin
- Designed for IT and Datacom applications



**Minitek® Pwr CEM-5 PCIe® Connector System**

- Newly launched CEM 5.0 PCI Express® 12VHPWR auxiliary hybrid connector and cable assembly solution
- Supports 600W GPU cards
- Rated current up to 9.5A per contact and features fully isolated terminals



**BarKlip® BK500 IO**

- Distributes up to 500A per contact
- Simple configurable plug-and-play solutions
- Fully compliant with ORv3 Power Output Specifications



**PwrBlade® Mini Cable-to-Board Connector**

- Rated up to 25A per power contact (50A/ column) without exceeding 30°C temperature rise in still air
- Modular tooling design
- 12AWG for power contacts and 26AWG-22AWG available for signal contacts



**PwrBlade® ULTRA HD**

- Up to 85A per contact
- 2.0mm high density signal pitch
- Ultra-low profile height of 9.6mm above board for optimized airflow



**BarKlip® BK150 IO**

- Distributes up to 150A per contact between busbars, cables, and circuit boards
- Simple configurable plug-and-play solutions
- Fully compliant with ORv3 IT Gear Power Input Solution Specifications



**PwrBlade® Mini Board-to-Board Connector**

- Rated up to 45A per high power contact (4 adjacent contacts)
- Low profile 8.10mm height above board
- Modular tooling designs



**PwrBlade® IO**

- Up to 60A per contact (high power) & 25A per contact (low power)
- Power & signal contacts are highly configurable
- Wide range of wire sizes available



**AC Input Connector and Cable Assemblies**

- 7-Pin connector designed for Star, Delta, and single-phase connections
- Simple configurable plug-and-play solution designed to meet various current and voltage ratings
- Fully compliant with OCP ORv3 Power Shelf Universal Input Connect Specifications



**PwrMAX® I/O Cable Connector System**

- Rated up to 50A/Contact (100A/column) without exceeding 30°C temperature rise in still air
- Latching options available
- Patented GCS® and GXT® plating



**BarKlip® XP300/ XP200**

- Current ratings up to 300A and 200A
- Mates with 3.0mm busbar
- ±2.0mm gatherability



**CoolPower® SDM**

- Up to 35A per pin, high current Coolband contact technology
- Backplane, coplanar, and orthogonal configurations available
- 2 position or 4 position available



**EnergyEdge™ X-treme**

- 3000W at 12V
- Available in straddle mount, right angle, right angle coplanar, and vertical configurations
- 25% increase in current linear density



**PwrMAX® G2**

- Highest density blind-mate Power and Signal connector series
- Up to 130A per contact and 18% size reduction
- Orthogonal, mezzanine, coplanar and right-angle configurations available for both PCB and busbar applications



# AI / Machine Learning High Speed



## ExaMAX®

COST OPTIMIZED WITH SCALABLE PERFORMANCE TO 112G PAM4  
Innovative design supports low insertion/extraction forces with reduced crosstalk and low insertion loss. Flexible architecture supports direct orthogonal, traditional backplane, coplanar and cable requirements.



## XCede® HD

SUPPORTS DESIGNS FROM 8G - 56G PAM4  
The de-facto standard for high performance backplane designs with industry leading density. Supports Embedded Capacitors.



## Chameleon®

COMPRISED OF A 76 POSITION 0.8mm PITCH CONNECTOR  
Designed and built for use in high-speed serial applications. Each port supports up to 800Gb/s in aggregate over an 8 x 112Gb/s electrical interface. The cage and connector design provides backwards compatibility to QSFP56 modules.



## Paladin®

SUPPORTS DATA RATES BEYOND 112G PAM4; INDUSTRY-LEADING SIGNAL TO NOISE PERFORMANCE  
Consistent signal integrity performance over the entire mating range. Flexible architecture supports direct orthogonal, traditional backplane, mezzanine, coplanar and cable requirements up to 8P.



## Paladin HD®

DENSITY OPTIMIZED PERFORMANCE BEYOND 112G PAM4; ROADMAP TO 224G  
Achieves 144 diff pairs within 1U Orthogonal slot. Consistent signal integrity performance over the entire mating range. Flexible architecture supports right angle female, direct orthogonal, and cables up to 12P.



## M-Series 56 Mezzanine Connectors

56GB/S HIGH SPEED MEZZANINE BGA CONNECTOR SYSTEM  
Leveraging proven technologies, including an industry leading BGA design, offering superior self-aligning and self-leveling. With a next generation differential pair contact design for up to 56Gb/s NRZ and 112Gb/s PAM4 performance.



## Lynx™ QD

THE QUAD DIFFERENTIAL SOLUTION  
Optimized for differential pair signaling, Lynx™ QD sets a new standard for density and flexibility that offers an innovative, high performance interconnect with PCIe® Gen 5 support. Lynx™ QD supports data rates of 56 Gb/s PAM4.



## Lynx™

HIGH SPEED AND DOUBLE DENSITY LOW-PROFILE BOARD-TO-BOARD CONNECTOR  
Amphenol's Lynx™ is a 4-row product offering doubling the density in a 2-row footprint that is suitable for a wide variety of applications in datacom, enterprise server, industrial, medical and more.

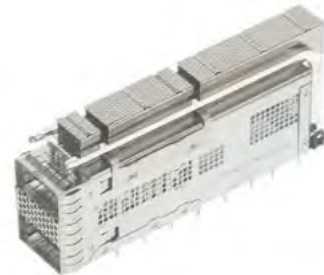

## ExtremePort™ QSFP DD 112G Connectors

COMPRISED OF A 76 POSITION 0.8mm PITCH CONNECTOR  
Designed and built for use in high-speed serial applications. Each port supports up to 800Gb/s in aggregate over an 8 x 112Gb/s electrical interface. The cage and connector design provides backwards compatibility to QSFP56 modules.



## ExtremePort™ OSFP 112G Connectors

112GB/S PAM-4 WITH UP TO 800GB/S AGGREGATED BANDWIDTH  
Amphenol's ExtremePort™ OSFP 112G interconnect system is comprised of a 60 position, 0.60mm pitch connector designed for high-speed serial applications.



## OSFP Loopback 200G/400G

200G / 400G SYSTEM CONFIGURATION SOLUTION  
Amphenol's OSFP (Octal SFP) Loopback Modules are part of our OSFP I/O system product family that includes copper cables, connectors and AOC's. These OSFP loopback cable assemblies are offered in four configurations.



## SK Series - Sockets

HIGH PERFORMANCE COMPRESSION MOUNT SOCKETS  
Amphenol's patented compression mount contact technology utilizes industry leading alloys to make cost effective and electrically robust socket solutions that offer high performance. With designs supporting pitches down to 0.4mm and speeds up to 40GHz.

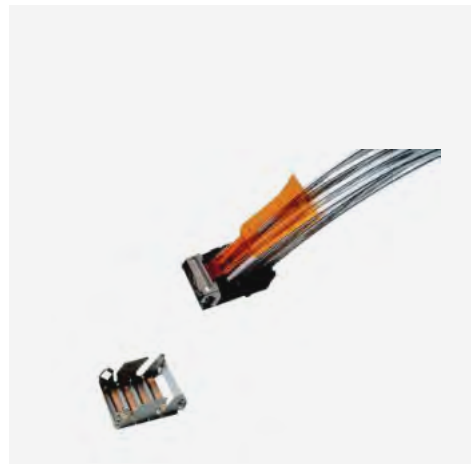

## DensiLink® OverPass™ Assemblies

112G DOUBLE ENDED HIGH PERFORMANCE CABLING INTERCONNECT  
DensiLink® OverPass™ products remove high speed signaling from the PCB and create a double ended, high performance cabling interconnect. These cables support 56G and 112G signaling in hardware system designs.



## QSFP DD Copper Cable Assemblies 200G/400G/800G

DOUBLE DENSITY PASSIVE COPPER CABLE ASSEMBLIES  
The next-gen QSFP DD cables now enable 400G and 800G in application lengths from 0.5 meter up to and including 3 meters. Available in all 4x form factors.

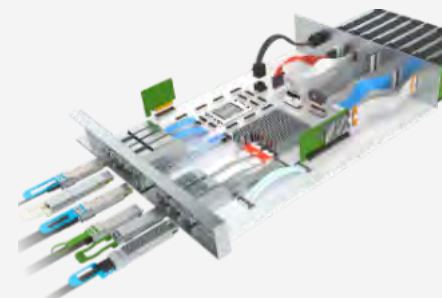

## OverPass™ Cable System

INDUSTRY-LEADING DIRECT HIGH-SPEED INTERCONNECT  
Amphenol's OverPass™ cable system offers a broad range of capabilities that allow our customers to efficiently transmit high speed signals from near an ASIC to anywhere in their system.



## OSFP Copper Cable Assemblies 200G/400G/800G

OCTAL SMALL FORM FACTOR PLUGGABLE CABLE ASSEMBLIES  
Compatible with 25G/lane channel NRZ up to 112G/lane channel PAM4 signaling protocols that allow the cables to deliver aggregate bandwidths of 200G, 400G, and 800G per cable assembly.



## QSFP DD Loopback 200G/400G

200G / 400G SYSTEM CONFIGURATION SOLUTION.  
Amphenol's QSFP DD (Double-Density) Loopback Modules are part of our comprehensive QSFP DD product family offering - cables, connectors and AOC's. These QSFP DD loopback cable assemblies are offered in four configurations.



## Mini-SAS HD Active Optical Cable

RELIABLE HIGH PERFORMANCE INTERCONNECT SOLUTION FOR MSAS APPLICATIONS  
Amphenol's Mini-SAS HD Active Optical Cable is fully compliant to SAS 2.1 and SAS 3.0 industry standards as well as the SFF-8636 interface standard. Used primarily for external Enterprise storage applications.

# HEILIND

---

heilind.com | 800.400.7041

# Amphenol

COMMUNICATIONS SOLUTIONS

amphenol-cs.com



amphenol-cs



amphenolcs



AmphenolCS



Amphenol\_CS

